



**DECISION SUPPORT FOR THE
CONSERVATION AND MANAGEMENT
OF ESTUARIES**

**Final Report of the Predictive
Capability Sub-Project of the
Co-ordinated Research Programme**

JH Slinger

WRC Report No. 577/2/00

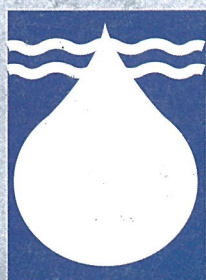

**Water
Research
Commission**

**FINAL REPORT OF THE
PREDICTIVE CAPABILITY SUB-PROJECT
OF THE CO-ORDINATED RESEARCH PROGRAMME
ON DECISION SUPPORT FOR THE CONSERVATION
AND MANAGEMENT OF ESTUARIES**

Compiled by

J H Slinger

**Report to the
WATER RESEARCH COMMISSION**

**by the
CONSORTIUM FOR ESTUARINE RESEARCH
AND MANAGEMENT**

**WRC Report No 577/2/00
ISBN 1 86845 635 8**

EXECUTIVE SUMMARY

The Consortium for Estuarine Research and Management decided at the outset that the approach of the Co-ordinated Research Programme on Decision Support for the Conservation and Management of Estuaries would be to support existing decision support procedures for estuarine management as far as possible. The development and implementation of alternative procedures would only be undertaken if those currently in use were deemed inappropriate. Accordingly, a decision was taken to support the Integrated Environmental Management procedure which is advocated by the Department of Environmental Affairs and Tourism and forms the basis of current decision making regarding the freshwater requirements of rivers and estuaries as undertaken by the Department of Water Affairs and Forestry. In this regard, the Predictive Capability sub-project was initiated with the following objectives:

- To establish the state of decision support in terms of existing mathematical models, their data requirements, limitations, ranges of applicability and actual applications,
- To investigate possible interlinkages between different models, to establish data and software requirements for the interlinkages and to undertake linkage of the models where useful and viable,
- To identify model development requirements in terms of existing models, improved interlinkages or new model formulation,
- To use a case study approach to test the application of this decision support module,
- To identify data and information requirements for effective model implementation and so provide focus for research proposals to enhance general predictive decision support in estuaries.

At the inception of the project, it was unclear whether an integrated modelling approach was feasible. However, five existing models relating to the determination of the freshwater requirements of estuaries were identified, none of which had been applied in a linked fashion previously nor had they been applied to the same system. Despite these limitations, capabilities for short term prediction and long term prediction were identified and a conceptual plan for interlinkage of the models was developed. The models comprising the short term predictive capability, namely the Mike 11 hydrodynamic and transport-dispersion model, the Mike 11 water quality module and the Plant Estuarine Decision Support System (PEDSSys) were in a more advanced stage of development than those comprising the long term predictive capability. Substantial developments were undertaken in the long term modelling capability during the project, resulting in improvements to the Estuarine Systems Model (ESM) and the Estuarine Ecosystem Evaluation Model (EEEM). Additionally, the development of a spatial, dynamic biomass growth model for estuarine macrophytes (DVM) was initiated and a procedure, termed the faunal prediction module (FPM), for incorporating existing expertise on faunal responses in the decision support capability was formalised.

Case study applications were undertaken on two estuaries for which data related to reductions in freshwater flows were available. Study sites representative of two categories of South African estuary, namely temporarily closed (the Great Brak Estuary) and permanently open (the Kromme Estuary) systems, were selected so that information on the limitations of the models, their ranges of applicability and critical development requirements could be obtained. The linked modelling system was implemented on the case studies by first simulating the abiotic response of an estuary to a range of inflow scenarios and then predicting the biotic responses. The case study applications demonstrated that:

- Mike 11 is optimally applied to a permanently open estuary in which the axial variation in salinities is of importance,
- the Mike 11 water quality module may be applied to both the Great Brak and Kromme Estuaries, but further data is required before adequate calibration can be achieved,
- the simulation results from the Mike 11 system can usefully be employed by the Plant Estuarine Decision Support System to generate predictions of the responses of estuarine macrophytes to the altered physical conditions (flows, water levels and salinities) arising from reductions in freshwater flow,
- the Estuarine Systems Model is able to predict the physical environmental response (water levels, mean salinities, stratification-circulation state, tidal fluxes, axial salinity differences and sill heights at the mouth) of both permanently open and temporarily closed estuaries,
- the simulation results generated by the ESM are useful for the predictions by PEDSSys of the effects of mouth closures and associated alterations in water levels and salinities on estuarine macrophytes in a temporarily closed estuary,
- the Dynamic Vegetation Model is able to provide quantitative predictions, which complement the qualitative predictions of PEDSSys, of the responses of the estuarine macrophytes to the physical conditions simulated by both Mike 11 and the ESM,
- based on ESM results, the Estuarine Ecosystem Evaluation Model is able to predict the effects of different mouth closure scenarios on the population size and structure of the mud prawn in a temporarily closed system and indicate the effects on fish recruitment of reductions in freshwater flow to both permanently open and temporarily closed systems,
- a workshop procedure for eliciting expert prediction of the effects of reduced run-off on faunal functional groups may be applied, as in the case of the Kromme Estuary.

Thus at the end of the first three years of the predictive capability sub-project, an effective system of linked models has been developed and applied to both a permanently open and a temporarily closed estuary. Apart from Mike 11, the models comprising the linked system have undergone considerable development since the start of the project and increased confidence can now be placed in their predictions. Moreover, rather than separate capabilities for short and long term prediction as initially envisaged, the models have been applied in a complementary fashion. For instance, the Estuarine Systems Model is used to simulate the opening and closure of an estuary mouth over time in a temporarily closed system, which Mike 11 cannot model, and Mike 11 is

used to simulate the water levels, flows and salinities at different positions in an estuary, which the ESM cannot model. Thus, scenario-based simulation using the linked modelling system has proved effective in predicting the consequences of reduced freshwater flows to estuaries and has considerably enhanced the scientific understanding of these effects on the Kromme and Great Brak Estuaries.

There are multiple entry points into the predictive capability and its application. These arise from the shared understanding, developed amongst CERM members and modellers over the duration of the project, of the required linkages in terms of data and the appropriate complexity of model applications. For effective implementation, the predictive capability can be applied at different levels of detail from the stage of applying an individual model, to just convening a meeting of all modellers/estuarine scientists and drawing upon their predictive expertise, to a full application of the linked modelling system. For the worst case of a data- and time-poor situation in which predictions are required, a staged approach involving model implementation, data collection and refinement of the initial scenario-based assessments has been developed. However, informed decision making relies heavily on the availability of reliable information and the specification of model data requirements and monitoring data requirements is regarded as an area in which the decision support system can assist in directing more fundamental research efforts and can inform the formulation of a monitoring strategy at a national level.

ACKNOWLEDGEMENTS

Research funding from the Water Research Commission is gratefully acknowledged and Drs Peter Reid and Steve Mitchell and Mr Charles Chapman are thanked for their involvement with the project. Prof Charles Breen is thanked particularly for his overall guidance of the estuarine research projects, while members of the Consortium for Estuarine Research and Management are thanked generally for their participation in workshops and their commitment to excellence in research and management.

This project was undertaken by a team of estuarine scientists and modellers. The primary participants in this research project were:

Janine Adams
Guy Bate
Jean Boroto
Joanne Busse
John Hearne
Piet Huizinga
Nevil Quinn
Jill Slinger

In addition, the specialist contributions of the following people at project workshops are acknowledged:

Dan Baird
Iain Bickerton
Ticky Forbes
Alan Ramm
Alan Whitfield
Tris Wooldridge

The project co-ordination and report compilation were undertaken by Jill Slinger.

CONTENTS

	<u>Page</u>
EXECUTIVE SUMMARY	
ACKNOWLEDGEMENTS	
1. INTRODUCTION	1
2. METHOD	3
3. THE LINKED MODELLING SYSTEM	6
3.1 Description of Relevant Models and Their Development Status	6
3.2 The Linked Modelling System	13
4. IMPLEMENTING MODEL LINKAGES: THE KROMME CASE STUDY	16
4.1 The Kromme Estuary	16
4.2 Inflow Scenarios for Estuarine Model Applications to the Kromme Case Study	16
4.3 Implementing Short Term Prediction on the Kromme Case Study	20
4.4 Implementing Long Term Prediction on the Kromme Case Study	48
5. IMPLEMENTING MODEL LINKAGES: THE GREAT BRAK CASE STUDY	71
5.1 The Great Brak Estuary	71
5.2 Run-off Scenarios for Estuarine Model Applications to the Great Brak Case Study	73
5.3 Implementing Prediction on the Great Brak Case Study	74
6. DISCUSSION AND CONCLUSIONS	116
6.1 The Linked Modelling System: Summary of Results	116
6.2 Use of the Predictive Capability for Estuaries	119
REFERENCES	122
LIST OF FIGURES	125
LIST OF TABLES	130
APPENDIX	

1. INTRODUCTION

Prediction of the consequences of the abstraction of water from a river system on the downstream estuary is necessary in South Africa where freshwater is in limited supply. The Predictive Capability Sub-project of the Co-ordinated Research Programme on Decision Support for the Conservation and Management of Estuaries was initiated in an effort to develop competence in this area. The objectives of the sub-project were:

- To establish the state of decision support in terms of existing mathematical models, their data requirements, limitations, ranges of applicability and actual applications,
- To investigate possible interlinkages between different models, to establish data and software requirements for the interlinkages and to undertake linkage of the models where useful and viable,
- To identify model development requirements in terms of existing models, improved interlinkages or new model formulation,
- To use a case study approach to test the application of this decision support module,
- To identify data and information requirements for effective model implementation and so provide focus for research proposals to enhance general predictive decision support in estuaries.

At the inception of the project, it was unclear whether an integrated modelling approach was feasible. However, five models relating to the determination of the freshwater requirements of estuaries were identified, none of which had been applied in a linked fashion previously and most had not even been applied to the same systems. Despite these limitations, capabilities for short term prediction and long term prediction were identified and a conceptual plan for interlinkage of the models was drawn up. The models comprising the short term predictive capability, namely the Mike 11 hydrodynamic and transport-dispersion model, the Mike 11 water quality module and the Plant Estuarine Decision Support System (PEDSSys) were in a more advanced stage of development than those comprising the long term predictive capability. Substantial developments were undertaken in the long term modelling capability, resulting in improvements to the Estuarine Systems Model (ESM) and the Estuarine Ecosystem Evaluation Model (EEEM). Additionally, the development of a spatial, dynamic biomass growth model for estuarine macrophytes (DVM) was initiated and a procedure, termed the faunal prediction module (FPM), for incorporating existing expertise on faunal responses in the decision support capability was formalised.

Two case study applications were undertaken. The case study sites were chosen primarily on the basis of the availability of data related to reductions in freshwater flows. However, sites representative of two categories of South African estuary, namely temporarily closed (the Great

Brak Estuary) and permanently open (the Kromme Estuary) systems, were selected so that information on the limitations of the models, their ranges of applicability and critical development requirements could be obtained. The implementation of the linked modelling system on the case studies demonstrated that:

- Mike 11 is optimally applied to a permanently open estuary in which the axial variation in salinities is of importance,
- the simulation results from the Mike 11 system can usefully be employed by the Plant Estuarine Decision Support System to generate predictions of the responses of estuarine macrophytes to the altered physical conditions (flows, water levels and salinities) arising from reductions in freshwater flow,
- the Estuarine Systems Model is able to predict the physical environmental response (water levels, mean salinities, stratification-circulation state, tidal fluxes, axial salinity differences and sill heights at the mouth) of both permanently open and temporarily closed estuaries,
- the simulation results generated by the ESM are useful for the predictions by PEDSSys of the effects of mouth closures and associated alterations in water levels and salinities on estuarine macrophytes in a temporarily closed estuary,
- the Dynamic Vegetation Model is able to provide quantitative predictions, which complement the qualitative predictions of PEDSSys, of the responses of the estuarine macrophytes to the physical conditions simulated by both Mike 11 and the ESM, and
- based on ESM results, the Estuarine Ecosystem Evaluation Model is able to predict the effects of different mouth closure scenarios on the population size and structure of the mud prawn in a temporarily closed system and indicate the effects on fish recruitment of reductions in freshwater flow to both permanently open and temporarily closed systems.

The ultimate measure of the success of the project lies in the fact that it was able to draw people with different areas of expertise together and cause them to collaborate to produce a functioning decision support tool for estuaries. To facilitate the inclusion of the new scenario-based estuarine predictive capability in existing decision making procedures, the application of different phases of the Integrated Environmental Management procedure (IEM) was associated with levels of complexity of model implementation. An understanding of the data required for implementation of the different levels of complexity therefore was developed, leading to an ability to identify the research projects necessary to support informed decision making on a site specific basis, as well as highlighting the need for long term monitoring of estuaries.

Thus, in describing the achievements of the Predictive Capability Sub-project, this report first details the study method (Section 2), then presents the status of estuarine modelling and the linked modelling system (Section 3) and next focuses on the implementations of the models on the Kromme (Section 4) and the Great Brak (Section 5) Case Studies. Thereafter, the significance of the findings of the project and their use are discussed (Section 6).

2. METHOD

In the first year of its inception, the research focused on identifying relevant models, establishing the data requirements and outputs of the models, the applications already undertaken and possible interlinkage of the models. Five models relating to the determination of the freshwater requirements of estuaries were identified. None of these models had been applied in a linked fashion previously and most had not even been applied to the same systems. A workshop was convened on 26, 27 May 1993 at the Botany Department of the University of Port Elizabeth at which modellers exchanged technical information on the five relevant models and explored the possibility of applying the models in a linked fashion. A conceptual framework for interlinkage was developed and consensus was achieved on the basic principles underpinning this collaboration, namely that data would be exchanged freely, that models would not be applied in isolation from relevant scientific expertise and that a case study approach would be adopted to demonstrate the utility of the interlinkages and investigate the model limitations.

The first case study selected was the Great Brak Estuary, a small intermittently closed system on the southern Cape coast, primarily because it was considered that sufficient data existed to facilitate the application of the models to this system. A schedule for initial application of the conceptual linked modelling system to the Great Brak Estuary was drawn up and freshwater run-off scenarios to the Great Brak Estuary were selected for testing. Following a five month implementation period, a second workshop was held on 13, 14 October 1993 at the CSIR in Stellenbosch. Progress on the application of the linkages to the case study was reviewed and issues such as the limitations of the models, their ranges of applicability, data requirements for effective model implementation and necessary model developments were addressed. The deliberations of the workshop were conveyed to interested members of the Consortium for Estuarine Research and Management in an information session immediately after the workshop and comments and criticisms were solicited. Thereafter, the agreed model developments were initiated and the required further activities and data exchanges were undertaken. The application of the linked modelling system to the first case study, the Great Brak Estuary, therefore, occurred within the first year of the initiation of the predictive capability sub-project. The results were presented at a CERM meeting in April 1994 and were summarised in the progress report for the first year (Slinger 1994).

The second case study was selected on the basis of data availability, the location of the estuary and the nature of the system and its problems as distinct from the Great Brak Estuary. Various options were debated by CERM members at a meeting in April 1994, including the Mgeni Estuary, the Kromme Estuary and the Great Berg Estuary. The Kromme Estuary was eventually selected by consensus as the next case study site. The major reasons for its selection included:

- it is a freshwater starved system which has been sampled extensively both before and after impoundment, and
- it has a permanently open mouth, unlike the Mgeni Estuary, and is thus sufficiently different from the Great Brak Estuary to facilitate analysis of the ranges of applicability of the models.

The first workshop on the Kromme Case Study was held in the Botany Department at the University of Port Elizabeth on 12 July 1994. Five inflow scenarios were suggested for preliminary consideration and the tasks necessary for the successful implementation of the linked modelling approach on the Kromme Estuary were listed and scheduled. The possible inclusion of a faunal prediction module, comprising a formal procedure for incorporation of the expertise of faunal specialists, was discussed and activities aimed at investigating this further were initiated. Links to network analysis and scenario planning were investigated through presentations by Prof Dan Baird of the University of Port Elizabeth and Ms Leanne Scott of the University of Cape Town, respectively.

Following an interim work period in which five inflow scenarios were specified, simulations were conducted and predictions were undertaken, a second workshop was convened on 13 October 1994 at the Botany Department of the University of Port Elizabeth and continued on 14 October 1994 at St Francis Bay on the Kromme Estuary. Presentations on initial results from Mike 11, PEDSSys, the ESM and the DVM were given and the outcome of a workshop held in early October 1994 to initiate the formalisation of existing knowledge of the responses of estuarine fauna, was described. The system of model linkages was adapted to include the new Faunal Prediction Module as a component of a predictive capability in estuaries. The workshop participants then divided into two groups with the faunal specialists undertaking prediction of the responses of the fauna of the Kromme Estuary to the original five inflow scenarios (implementing the FPM on the Kromme Case Study) and the modellers discussing further details of the Kromme Case Study application. The discussions arising from the implementation of the linked modelling approach led to the resolutions to implement further inflow scenarios and to investigate the effects of disturbance scenarios upon the long term dynamic equilibria resulting from the different inflow scenarios. Additionally, the need for the predictive capability to comply with an adaptive management approach in future was highlighted. The Kromme Case Study application was provisionally completed by March 1995 and the results were presented to CERM members for comment. The findings were summarised in the progress report for the second year of the predictive capability sub-project (Slinger 1995).

Because model developments were undertaken in the period between the application of the linked modelling system to the Great Brak and Kromme Case Studies, there were inconsistencies in the type of run-off scenarios considered eg. no disturbance scenarios predictions were undertaken

for the Great Brak Estuary, and the type of output produced by individual models differed eg. axial salinity differences were not predicted by the ESM at the outset nor was the fish recruitment index of the EEEM developed. Thus the third and final year of the project was devoted to the refinement and finalisation of the case study applications of the linked system of models. To this end, initial model simulations were undertaken and the results were discussed at a workshop on 6 December 1995 at the Mathematics Department of the University of Natal, Pietermaritzburg. Thereafter the remaining simulations were undertaken, the component reports were written and the results of the project were submitted to CERM members for comment and criticism in February 1996.

This technical report, therefore, summarises the findings and activities of the predictive capability sub-project over the full three year period from April 1993 to February 1996. The project participants and the various tasks undertaken for the predictive capability sub-project are listed in Table 1.

Table 1 The project participants and tasks involved in the development of the linked modelling system and its application to the Great Brak and Kromme Estuaries

TASKS	ACTIONS	RESPONSIBLE PEOPLE
Sub-project Co-ordination	Project Planning & Co-ordination, Organisation of Workshops & Briefing of Participants, Report Compilation & Presentation, Placement in the Wider DSS Context	Jill Slinger
Prediction & Simulation Modelling	Inflow & Disturbance Scenario Specification	Piet Huizinga, Jill Slinger
	Mike 11 Application	Piet Huizinga, Jean Boroto
	ESM Application	Jill Slinger
	WQ Simulation	Jill Slinger, Alan Ramm, Jean Boroto
	PEDSSys Application	Janine Adams, Guy Bate
	Dynamic Vegetation Modelling	Joanne Busse, John Hearne
	Faunal Response Modelling	Nevil Quinn
	Faunal Prediction Module	Dan Baird, Iain Bickerton, Ticky Forbes, Nevil Quinn, Alan Whitfield, Tris Wooldridge
Reporting	Component Reports	All

3. THE LINKED MODELLING SYSTEM

The present status of several models and modelling techniques capable of predicting the physical, chemical or biological responses of South African estuaries to freshwater inflows are described briefly. Thereafter, the system for linkage of these models, which was developed under the auspices of the predictive capability sub-project in order to provide a holistic predictive tool for estuarine management, is presented (Figure 2.1).

3.1 Description of Relevant Models and Their Development Status

3.1.1 The MIKE 11 Modelling System Including the Water Quality Module

Model Purpose

The one dimensional hydrodynamic and transport-dispersion modules of the MIKE 11 modelling system (DHI 1992) are designed to yield accurate water level variations, volume flows, velocities and cross-sectional average salinities along the length of an estuary over time periods from days to months.

Information Needs

Surveyed cross-section bathymetry, water level recordings at intervals along the estuary, either water level variation or volume flow information at the head and mouth of the estuary, longitudinal vertically averaged salinity data (preferably 3 data sets taken on neap tides 30 or so days apart).

Output

Time histories of water levels, flows, cross-sectional average velocities, cross-sectional average salinity concentrations at different positions along the length of the estuary may be obtained in the form of an ASCII file or excellent graphical output. The simulation period usually varies from days to months, although this may be extended to a year with increased computational effort and extensive manipulation of data files.

Technical Considerations

Short simulations may be undertaken on a 486PC, but longer simulations are run on a SUN Sparc Server 670MP under the Unix operating system. The source code of the modelling system is inaccessible. Implicit finite difference techniques, which are unconditionally stable, are used to solve the St Venant equations (DHI 1992). The time step is the major determinant in the

accuracy of simulation results. A time step of between 0,5 and 3 minutes is usually used. The modelling system is very user-friendly.

Model Applications

The Mike 11 modelling system was acquired in 1992. It replaced the NRIO 1-D hydrodynamic and transport-dispersion model (Huizinga 1985). The major advantage lies in its extreme user-friendliness, which enabled improvements in application and development times. The NRIO model was applied to the Great Brak, Wilderness, Swartvlei, Knysna, Keurbooms, Kromme, Swartkops, Sundays, Bushmans, Kariega, Great Fish, Mgeni and St Lucia Estuaries, whereas the Mike 11 model has been implemented fully on the Knysna, Swartkops, Great Berg, Great Brak, Kromme and St Lucia Estuaries and partially on the Hartenbos Estuary and the Wilderness system (Touws River Estuary) where the scour associated with flood flows was of particular interest. The topographic data necessary to set up the Mike 11 model are available for the Olifants and Breede Estuaries in addition to those systems to which the NRIO model was applied, but on which the Mike 11 model has not yet been implemented.

Water Quality Module

The water quality component of the Mike 11 modelling system comprises two primary modules, namely the advection-dispersion module and the water quality module. The advection-dispersion module of Mike 11 is used to simulate transport processes eg. the transport of salt or pollutant particle within an estuarine water body, whereas the water quality module deals with transforming processes of compounds in the estuary eg. oxygen depletion owing to organic loading, thermal heating of the water body, nitrification and denitrification amongst others. Although the model can accommodate the treatment of water quality issues at different levels of detail, the full range of processes which can be dealt with encompasses the heating and cooling of the water body and the generation and depletion of dissolved oxygen (DO) by re-aeration, photosynthesis, respiration, immediate and delayed degradation of organic matter, exchange with the river bed, nitrification and denitrification (DHI 1992). In the simplest application of the Mike 11 water quality module, the time evolution of the temperature, BOD and DO of an estuarine water body may be simulated.

Very few data relevant to the simulation of the water quality of South African estuaries are available. This fact together with the relatively recent acquisition of Mike 11 means that no calibrated applications of the Mike 11 water quality module exist for South African estuaries. Preliminary simulations of dissolved oxygen concentrations in the Great Brak and Kromme Estuaries under average present day run-off conditions have been performed. Little reliance can be placed in the results owing to the lack of calibration data. However, calibration of the water quality module on the Great Berg Estuary is underway at present and the potential applicability

of this component of the Mike 11 modelling system in addressing water quality aspects in South African estuaries is evident.

The Mike 11 Water Quality Module is suitable for application to most South African estuaries in that it can accommodate complex hydrodynamic features, unlike the Water Quality Systems Model developed by Alan Ramm of CSIR, Durban, which is most applicable to lagoon systems. The international acceptability of Mike 11 and the user-assist features which expedite model applications led to the selection of the Mike 11 Water Quality Module as the preferred option for full application of the linked modelling approach. The Water Quality Systems Model is considered a good option for use in a scoping study or for application to smaller systems such as commonly occur along the coast of Natal-KwaZulu (Alan Ramm *pers. comm.*).

3.1.2 The Plant Estuarine Decision Support System (PEDSSys)

Model Purpose

This expert system was developed to aid water management decisions relating to the freshwater requirements of estuarine plants (Adams & Bate 1994). In particular, the system is designed to answer questions on how changed inflow conditions (the addition or abstraction of freshwater) will affect estuarine plants. The categories of estuarine plants for which predictions can be made include: submerged macrophytes, emergent macrophytes, salt marsh macrophytes, phytoplankton and benthic microalgae.

Information Needs

The user is asked a series of questions (Section 5.2.3) which may require a quantitative or qualitative answer. The type of information required includes details on the variations in water level and how it affects the plants and sediment eg. duration of inundation and exposure events. Information on salinities and the time of exposure to specified salinities is required. For salt marsh and emergent macrophytes the season is also important, while for submerged macrophytes knowledge of the turbidity and water velocity is required. The presence or absence of pollutants has been included in the expert system as a general question. However, the effect of pollutants on estuarine plants is a complex issue that needs further knowledge refinement.

The response of phytoplankton is determined from the nitrate concentration of the inflowing water, the retention time of water and the presence or absence of vertical and horizontal salinity gradients. Information on the nitrate concentration and sediment type is required to determine the response of the benthic microalgae.

Output

The expert system provides a report stating the plants' scores. For estuarine macrophytes the score is a growth rate adjustment score between -10 and +10, where zero indicates no change. The score for phytoplankton and benthic microalgae is based on biomass and the scores range from 0 to +10. The rules triggered in arriving at the final score are indicated on request. The simulation period usually ranges from weeks to a year.

Technical Considerations

PEDSSys has been developed using the dmX for Windows expert system shell and is run on a 486PC. This shell has been developed locally by Decision Management Software. The computational basis of dmX utilises bilinear logic, recognized for its utility in applications which require judgemental, attitudinal or probabilistic reasoning. The program can be divided into Input, Inference (Scoring) and Reports. The user interface is Microsoft Access.

Model Applications

The present expert system knowledge base represents the predicted effect on the plant based on the best available data. This includes field work and applications of the system to estuaries in the eastern, southern and western Cape (Adams & Bate 1994). As information becomes available it is important that PEDSSys is tested and updated. Future developments include the addition of more plant categories, adding more plants to existing categories and the addition of graphic prompts.

3.1.3 The Estuarine Systems Model

Model Purpose

This model is designed to provide medium to long term (months to years) simulations of the physical dynamics (water levels, tidal fluxes, stratification-circulation states, mean salinities, tidal flushing, sill height at the mouth, axial salinity differences) of an estuary under different freshwater inflow scenarios (Slinger 1991, 1992) and to generate indices of management performance based on site-specific evaluation criteria. Thus the Estuarine Systems Model can:

- determine the consequences of changes in freshwater inflow conditions on the physical dynamics of an estuary, and
- evaluate the efficacy of management policies involving freshwater releases and mouth breaching.

Information Needs

The driving variables, which are specified by exogenous time-dependent functions include freshwater inflow, sea tidal variation (semi-diurnal as well as low frequency forcing), rainfall,

evaporation, groundwater flux and wave heights. The relationships between estuarine water volume, water level and surface area are required. Other required input information generally is readily obtainable from the literature e.g. the Estuaries of the Cape Part II Series. Data required for calibration purposes include inflow, water level recordings (especially in the vicinity of the mouth), tidal flux, the condition of the mouth (associated with different tidal fluxes and water level variations) and salinity measurements under different river flows and tidal conditions.

Output

Time histories (in ASCII) of freshwater inflow, water volume, water level, tidal flux, salt content, stratification, circulation, tidal flushing, axial salinity differences and the height of the sill at the mouth of the estuary are generated. Performance indices, which evaluate the state of the estuary against a reference state are also produced. Graphical output is available. The simulation period usually varies from three months to two years or greater.

Technical Considerations

The model runs on a SUN Sparc Server 670MP under the UNIX operating system. Access is via a 486 PC logged into the CSIR's local area network. The programming language is Fortran and the model is not particularly user friendly. The run time required for simulations is low (a matter of minutes), while the output time step is commonly set at about two hours. The integration routine used is the Runge-Kutta-Verner 5th order and 6th order method. The accuracy of the input data is such that one cannot predict the exact state of a system at a particular time, but rather can indicate the general behaviour or trends.

Model Applications

The Estuarine Systems Model has been applied and calibrated on the Great Brak and Kromme Estuaries.

3.1.4 The Estuarine Ecosystem Evaluation Model

Model Purpose

This model provides an index of ecosystem performance under different inflow and mouth conditions by simulating the population response of the estuarine mud prawn, *Upogebia africana*, using a cohort approach (Hearne & Quinn 1994), and by providing an index of fish recruitment based on axial salinity differences in the estuaries (Quinn *et al.* 1996).

Information Needs

Besides information on the population dynamics of the indicator species, input data on the inflow to the system, the condition of the mouth, tidal and water level variations, longitudinal salinity

distributions and temperatures are required for simulation of the response of the mud prawn. Data on indicator species abundance and migration rates under different flow and mouth conditions are required for calibration. Information on the head to mouth salinity differences in an estuary and the associated recruitment success of fish is required for calibration and application of the fish recruitment index.

Output

Time histories (in ASCII) of the biomass productivity index (calculated as a fraction of the theoretical maximum potential production) and size class frequency histograms of the *Upogebia africana* population are supplied. The success of fish recruitment is estimated as a percentage of a possible maximum. The simulation period ranges from months to years. General behaviour and trends can be predicted, but the accuracy of the modelling is not sufficient for prediction of the state of the ecosystem at a particular time.

Technical Considerations

The model is programmed in TurboPascal and runs on a 486 PC. The simulation time step is of the order of six hours to a day with the latter time step being the preferred option. The run time is reasonable (minutes to hours).

Model Applications

Both the invertebrate production index and the fish recruitment index components of the model have been applied to the Great Brak and Kromme Estuaries.

3.1.5 The Dynamic Vegetation Model

Model Purpose

The model was developed to indicate the spatial dynamic response of selected estuarine macrophytes (*Zostera capensis*, *Ruppia cirrhosa* and *Phragmites australis*) to different freshwater inflow conditions. The model indicates quantitatively the changes in the lateral distribution of biomass (from the centre of the estuary to the river bank) at different distances from the mouth of the estuary, owing to alterations in freshwater input (Busse *et al.* 1994).

Information Needs

Data on the duration and depth of inundation, the duration and extent of exposure, the salinity and current velocities experienced by the different estuarine macrophytes are required. In addition, information from the Estuarine Systems Model is needed to determine time-dependent functions.

Output

Time histories of biomass and productivity are generated for the different estuarine macrophytes at individual sites along the estuary. Total biomass and productivity figures may be produced. Graphical output is available.

Technical Considerations

The model is programmed in TurboPascal and runs on a 486 PC. The simulation time step is one day.

Model Applications

The model has been applied to the Great Brak and Kromme Estuaries.

3.1.6 Faunal Prediction Module

Considerable expertise exists regarding the response of estuarine fauna to variations in mouth condition and freshwater inflow to South African estuaries, but little of this knowledge of responses has been formalised into an expert system or simulation model. In contrast, much of the knowledge of the responses of the estuarine flora to alterations in inflow and mouth conditions has been formalised eg. PEDSSys and DVM. In an attempt to indicate the complementary role which such a predictive component can play, a faunal prediction module was identified. This module comprises a workshop procedure in which faunal experts generate qualitative predictions of the responses of different functional faunal categories to the predicted physical conditions in an estuary and comment on the results of the faunal predictions generated by the EEEM.

A measure of the success of this procedure is the development of a fish recruitment index, which was identified as necessary for improved faunal response prediction during the second year of the project. The formulation and application of such an index within the Estuarine Ecosystem Evaluation Model was subsequently initiated.

3.1.7 Network Analysis and Scenario-based Multicriteria Policy Planning

Network analysis is not a simulation modelling approach, but rather an ecosystem structure analysis procedure. As such, it does not fit naturally into the interlinked estuarine modelling approach as implemented on the Great Brak and Kromme Case Studies. However, the information that network analysis can provide on the changes in the structure and functioning of the Kromme Estuary and the level of stress on the ecosystem in the years from 1984 to 1992

(Baird & Heymans 1994) is useful as a benchmark against which to test the simulation predictions arising from the linked modelling approach.

The possibility of incorporating the scenario-based multicriteria policy planning procedure (Stewart *et al.* 1993) into the linked simulation modelling approach was investigated in a preliminary fashion. Multicriteria policy planning focusses on evaluating the benefits of a number of planning scenarios compared with one another. However, the aim of the modelling project is to develop the linkages which will enable the simulation of a range of inflow scenarios and prediction of the effects on different aspects of the estuary e.g. physical character, indicator fauna, estuarine macrophytes and phytoplankton. At this stage in the project, the inclusion of multicriteria policy planning would divert attention from the major thrust of the research which is aimed at developing a sound predictive capability in estuaries and focus attention on the inter-comparison and evaluation of the acceptability of scenario results instead. This consideration as well as delays in the generation of simulation results, meant that an evaluation of the utility of such an approach was not incorporated in the project, but does not exclude this as a useful undertaking in future.

3.2 The Linked Modelling System

The linked system of estuarine models is depicted in Figure 2.1. The underlying logic adopted in the design of the model linkages is that if one can predict the physical and chemical response of the estuary, one can then predict components of the ecosystem response. The models simulating the response of the physical environment to different inflow scenarios are the Mike 11 hydrodynamic and transport-dispersion modules and the Estuarine Systems Model. However, these models operate most effectively over different time scales, with the Mike 11 modelling system performing optimally in the supply of short term, accurate predictions and the systems modelling approach simulating the responses over the medium to long term (months to years). Therefore, the Mike 11 modelling system is viewed as primarily underpinning a short term predictive capability, whereas the ESM is the cornerstone of a long term predictive capability. However, it should be noted at the outset that the two physical modelling approaches are essentially complementary with the Mike 11 data often providing a basis for calibration of the ESM and the ESM providing an indication of the degree of stratification present in a system or indicating the response of the mouth to alterations in freshwater flow. The other models predominantly utilized in short term predictions are the Water Quality Module of Mike 11, the Plant Estuarine Decision Support System and the structured approach to the prediction of the short term faunal response by acknowledged scientific experts, which is termed the Faunal Prediction Module (FPM). The interlinkages between these models are depicted in Figure 1 as are those

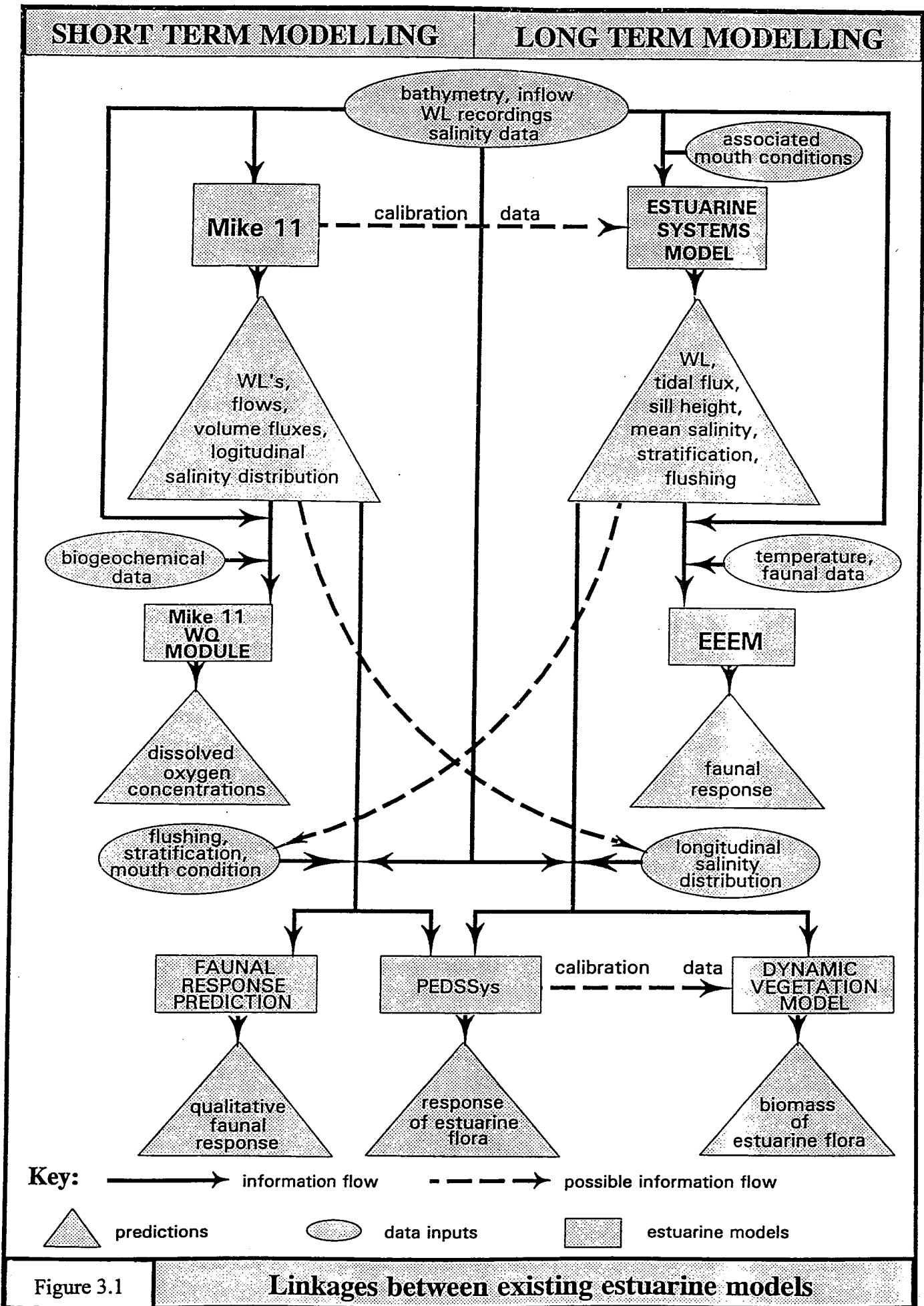

Figure 3.1

Linkages between existing estuarine models

between the models primarily comprising the long term predictive capability, namely the Estuarine Systems Model, the Estuarine Ecosystem Evaluation Model and the Dynamic Vegetation Model. As with the physical dynamics models, strong interlinkage between the short and the long term predictive capabilities occurs in the exchange of information which occurs between PEDSSys and the DVM and between the EEEM and the FPM. Where considerable changes in mouth condition are not anticipated and sharp alterations in freshwater flow are not considered, the Mike 11 model can also be used up to a period of a year (long term prediction). Repetitive application of PEDSSys enables it to be used for this period and longer. Thus, although the individual models are used primarily for long or short term applications, there is considerable overlap in their ranges of application and this leads to a comprehensive predictive capability for estuaries for time periods of weeks to years.

Although the development of software linkages for the exchange of data was initially considered, it soon became evident that considerable expertise is involved in using the data supplied by the physical models to generate insightful predictions from the ecosystem models. Thus the interlinkages developed in the predictive capability sub-project are envisaged as comprising linked modelling systems, procedures for the exchange of data between modelling experts, linkage of the computing resources of various research institutions and channels of communication between modellers at the various institutions and between modellers and estuarine scientists. The latter linkage is deemed important as all model predictions must be subject to verification by scientists with expertise in the respective fields.

4. IMPLEMENTING MODEL LINKAGES: THE KROMME CASE STUDY

To test the applicability of the linked modelling system and explore the limitations and ranges of applicability of the individual models, it was decided to implement the approach on two South African systems, namely the Great Brak and Kromme Estuaries. The application to the Kromme Estuary, a permanently open system located about 80 km to the west of Port Elizabeth, is presented first.

4.1 The Kromme Estuary

The Kromme Estuary is a narrow, sinuous water body extending for about 14 km from a permanently open mouth to a rock sill which forms the head of tidal influence (Figure 4.1). Channel depths of 1,5 m characterise the lower reaches (6,6 km upstream of the mouth), whereas depths of between 3 and 5 m are measured in the middle and upper reaches. Owing to impoundment in the catchment, the only guaranteed freshwater flow to the Kromme Estuary at present (apart from overflows from dams during floods), is 2×10^6 m³ per annum allocated for ecological purposes. Because little freshwater enters the system, the water column is generally vertically mixed with salinities averaging 32 ppt and greater throughout the estuary (Slinger 1989, CSIR 1994). Hypersalinities of the order of 45 ppt have been measured in the upper reaches (Baird *pers. comm.*, Wooldridge *pers. comm.*). The present state of the estuary is considered by ecologists to be that of a sheltered arm of the sea with a low productivity relative to other comparable permanently open estuaries (Ninham Shand Inc., 1994).

4.2 Inflow Scenarios for Estuarine Model Applications to the Kromme Case Study

The Kromme Estuary presently receives less than 2%, on average, of the run-off it would have received under natural conditions. However, in investigating the applicability of the linked modelling approach to the prediction of the consequences of reductions in freshwater flow to an estuary, it was deemed unnecessary to confine ourselves to the present situation. Instead the opportunity presented itself to test our ability to predict the response of an estuary to specific freshwater inflows and, by considering a range of inflows from the natural situation to a condition of no freshwater input, determine the change in state associated with alterations in inflow. Consequently, a range of such inflow scenarios was selected for consideration in the Kromme Case Study. Apart from Scenario 1, all releases are assumed to occur at the maximum

4.3 Implementing Short Term Prediction on the Kromme Case Study

Unlike the Great Brak Estuary, where the major determinant of the physical dynamics is the state of the mouth (that is, whether and how often the mouth is closed or open and, if open, to what depth), the mouth of the Kromme Estuary is permanently open. Furthermore, the volume of water entering and leaving the estuary on ebb and flood tides is of sufficient magnitude to maintain the mouth in a permanently open state, provided the volumes of sediment and the rates of delivery to the estuary are comparable with present day quantities. In this study, we are specifically assuming that the discharge velocity of freshwater does not exceed the maximum release rate of the upstream impoundment, that is, 22 m³/s. Flow of this magnitude is insufficient to cause substantial movement or delivery of sediment to the Kromme Estuary (CSIR 1991). Thus, the implications of the inflow scenarios for the sediment balance of the Kromme Estuary are not addressed in this study. Rather, the existence of the upstream impoundment is acknowledged in terms of its effect on the maximum inflow rate, but the present management strategy for water releases is ignored in terms of the volumes of water considered to be received by the estuary.

4.3.1 The Mike 11 Hydrodynamic and Transport-Dispersion Model

Calibration of the hydrodynamic module was achieved through comparison of model results with the water level and current velocities measured in August 1988 (Slinger 1989), whereas calibration of the coupled transport-dispersion module was achieved by comparing model outputs with salinity data collected on eight occasions by the University of Port Elizabeth from April 1993 to March 1994. Mean monthly evaporation and precipitation figures were supplied by the Department of Water affairs and Forestry. Details of the calibration procedure followed are given in CSIR (1994).

Model simulations were conducted for a full year commencing on 1 October under each of the run-off scenarios. The mean salinity in the estuary was assumed to be that of sea water (34,5 ppt) at the start of the simulations, which occurred at spring tide. The early summer release began on 15 November under scenarios 2, 4, 6, 7 and 8.

Model Results

1. *The natural run-off scenario*

The natural run-off scenario was simulated by imposing the seasonality of the Eastern Cape region on the average annual run-off. This is rather unrealistic in that the fast flowing, high

release rate of the Mpopfu Dam, which is between 20 and 22 m³.s⁻¹.

1. *Pre-development/natural run-off scenario*

The natural MAR of the Kromme Estuary is approximately 120 x 10⁶ m³/yr with natural seasonality and flooding. The estimated natural (pristine) condition is included as a run-off scenario, despite a lack of quantitative data, because it provides a reference point from which the change in estuarine condition can be evaluated as a consequence of changes in run-off to the estuary. Simulation results from this scenario, therefore, provide information on salinity distributions in the estuary prior to the construction of the Mpopfu Dam.

2. *Intermediate run-off scenario: 10% of natural MAR*

The run-off scenario commonly specified in an Instream Flow Requirement Worksession includes an annual allocation for base flow, a freshette and a flooding volume and timing as deemed necessary to maintain the functioning of the estuarine ecosystem. In the case of the Kromme Estuary, the base flow and flooding requirements are respectively taken to be the evaporative requirement (2,372 x 10⁶ m³/yr) and the 1 in 2 year flood volume (8,610 x 10⁶ m³/yr) set by Jezewski and Roberts (1986). The optimal timing of the annual flood volume would be early summer (with some inter-annual variation in timing being desirable). The freshette is set at 1 x 10⁶ m³/yr to occur in late summer, that is about 4 months after the flood, which would usually occur in November.

3. *Present run-off scenario*

Monthly releases over one day of one twelfth of the total annual volume of 2 x 10⁶ m³/yr. Only the salinity of the region at the head of the estuary is affected by these releases. This release pattern is aimed at preventing the occurrence of hypersalinities.

4. *Alternative run-off scenarios totalling an annual volume of 2 x 10⁶ m³/yr*

- (a) One large release per year (in early summer)
- (b) Two releases of equal volume per year (early summer and six months later)
- (c) Two releases of equal volume per year (early summer and four months later)
- (d) Three releases per year (large release in early summer, 2 smaller releases later but not in winter)

In the case of the alternative run-off scenarios totalling an annual volume of 2 x 10⁶ m³/yr, the object is to investigate the use of this volume of water in creating axial gradients of 20 ppt, 15 ppt and 10 ppt within the estuary and to optimise the persistence and intensity of these gradients over a year. Owing to the use of most of the allocated water in one or two burst releases, hypersalinities might occur later in the hydrological year (1 October to 30 September).

5. *No freshwater releases*

This scenario is included so that the occurrence and extent of hypersalinities in the absence of freshwater releases can be investigated.

6. *Intermediate run-off scenario: 20% of natural MAR*

An annual flood equivalent to the 1 in 2 year flood ($8,610 \times 10^6 \text{ m}^3/\text{yr}$) is set to occur in early summer (October/November), while a late summer flood of volume $2 \times 10^6 \text{ m}^3$ occurs four months after the first flood. The remainder of the annual allocation of $24 \times 10^6 \text{ m}^3$ is assumed to enter the estuary as a continuous base flow i.e. $13,39 \times 10^6 \text{ m}^3/\text{yr}$ or $0,425 \text{ m}^3/\text{s}$. Note that this inflow scenario has a total annual allocation double that of the intermediate run-off scenario 2.

7. *Intermediate run-off scenario: 40% of natural MAR*

An annual flood equivalent to the 1 in 2 year flood ($8,610 \times 10^6 \text{ m}^3/\text{yr}$) is set to occur in early summer (October/November), while a late summer flood of volume $2 \times 10^6 \text{ m}^3$ occurs four months after the first flood. The remainder of the annual allocation of $48 \times 10^6 \text{ m}^3$ is assumed to enter the estuary as a continuous base flow i.e. $37,39 \times 10^6 \text{ m}^3/\text{yr}$ or $1,186 \text{ m}^3/\text{s}$. Note that this inflow scenario has a total annual allocation double that of the intermediate run-off scenario 6 and four times that of the intermediate run-off scenario 2.

Additionally, the effects of perturbations to the estuarine states arising from the imposition of the inflow scenarios 1 to 7 can be investigated by considering disturbance scenarios. Note that ideally every disturbance scenario selected should be simulated by all of the models for each of the seven scenarios. In order to make a disturbance analysis practically possible, we decided to limit the disturbance scenarios considered to two. The selected scenarios relate to a drought situation, the most likely perturbation to an annual water allocation policy in the semi-arid Eastern Cape region. The disturbance scenarios selected for consideration are:

A. *No freshwater flow to the estuary for one year*

B. *No freshwater flow to the estuary for three consecutive years.*

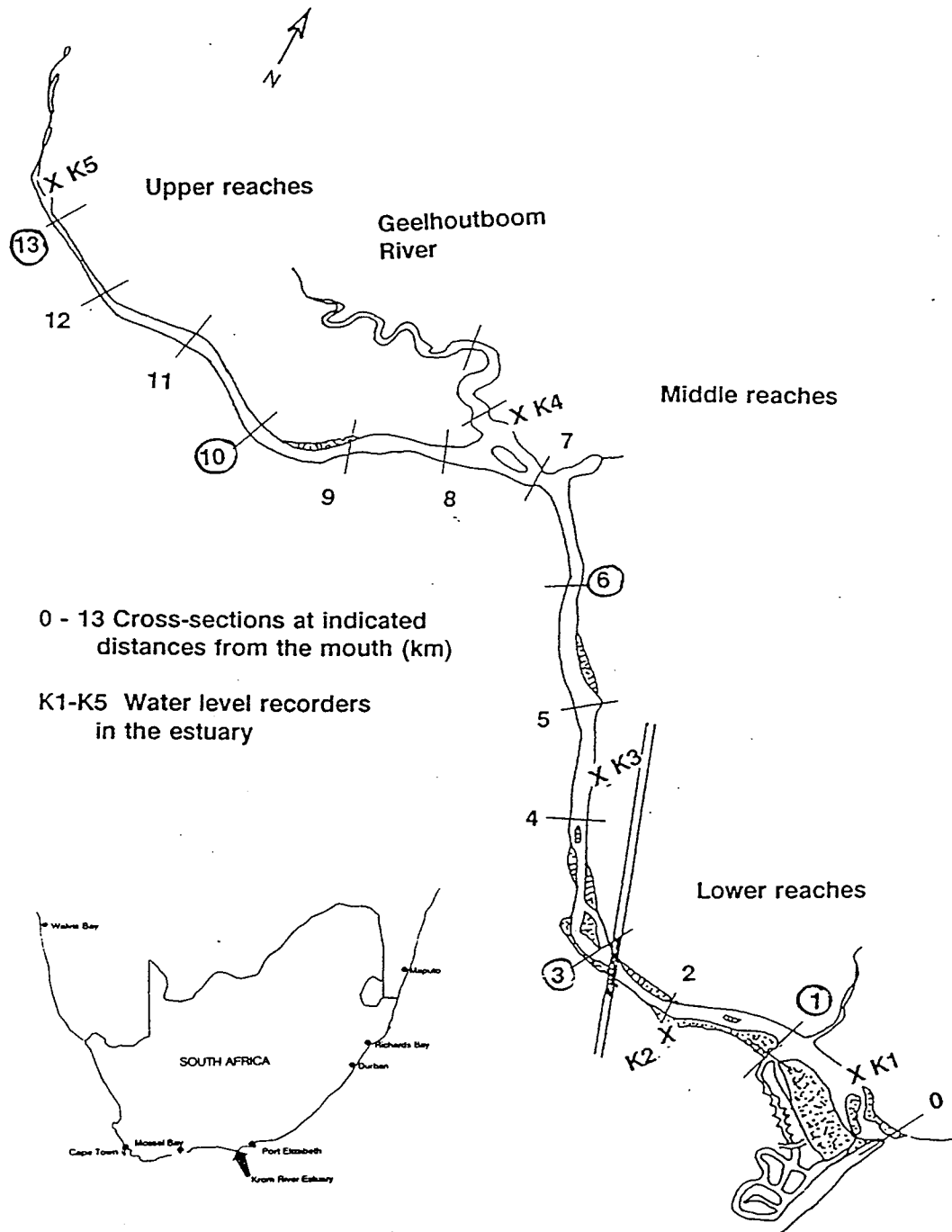

Figure 4.1 Map of the Kromme Estuary, the case study site. Note the positions of the ringed cross-sections for which water level, salinity and flow data are provided by the Mike 11 model. The upper reaches of the estuary are considered to extend from the head of tidal influence (14 km upstream of the mouth) to the confluence with the Geelhoutboom River, the middle reaches to cross-section 4, while the shallow, lower reaches lie downstream of this point.

volume floods which would have occurred under natural conditions are not simulated, nor are the low base flow periods which would have occurred in the dry season. However, the average situation is well simulated. The model results, presented in Figure 4.2, indicate that the head of the estuary would have been fresh throughout the year with salinities greater than 5 ppt occurring immediately below the confluence with the Geelhoutboom tributary only in mid summer. Four kilometres upstream of the mouth salinities varied between 10 and 30 ppt in mid summer and between 0 and 20 ppt in winter. At the mouth, salinities varied between 24 and 34,5 ppt in summer and between 7 and 34,5 ppt in winter. Clearly, the upper reaches of the estuary are fresh throughout and the model results indicate that the differences in salinity between the head of the estuary and the sea are approximately 34,5 ppt all year.

2. *The intermediate run-off scenario (10% of the natural MAR)*

The 1 in 2 year flood on the 15 November, flushes the estuary with freshwater (Figure 4.3). While freshwater persists at the head of the estuary for about 15 days, the effect of the flood is short-lived at the mouth and salinities vary between 27 and 34,5 ppt with the tide by the end of November. In the middle reaches salinities vary between 10 and 25 ppt by the end of November and by March lie in the range 31 to 34,5 ppt, whereas at the head of the estuary 25 ppt is only attained in March. When the late summer release reaches the estuary on 15 March, salinities at the head of the estuary decrease to zero, but salinities in the middle reaches only decrease to between 22 and 27 ppt. Salinities at the mouth decrease slightly, but the effect is temporary. By the end of June, the salinities of the middle reaches exceed 30 ppt and the upper reaches have salinities of 25 ppt and greater. This situation persists for the rest of the year.

3. *The present run-off scenario*

The influence of the monthly freshwater releases is confined to the upper reaches of the estuary with salinities at the head of the estuary decreasing from about 34,5 ppt to between 16 and 20 ppt immediately after a release (Figure 4.4). Below the confluence with the Geelhoutboom river, salinities generally exceed 30 ppt. At the mouth, salinities are near those of the sea (between 34 and 35 ppt) throughout the year. Thus under the present release scenario, the estuary is marine-dominated and has no permanent brackish component.

4. *Alternative run-off scenarios totalling an annual volume of $2 \times 10^6 \text{ m}^3$ per annum*

(a) *One large release per year (in early summer)*

Under this release scenario, no freshwater enters the estuary from 1 October to 15 November. By this time, the upper reaches of the estuary are exhibiting slight hypersalinities in view of the fact that sea salinities throughout were assumed as an initial condition of the simulation run. However, when the annual release reaches the estuary in mid November, Mike 11 predicts that the upper reaches of the system are flushed with freshwater. The salinities of the middle reaches

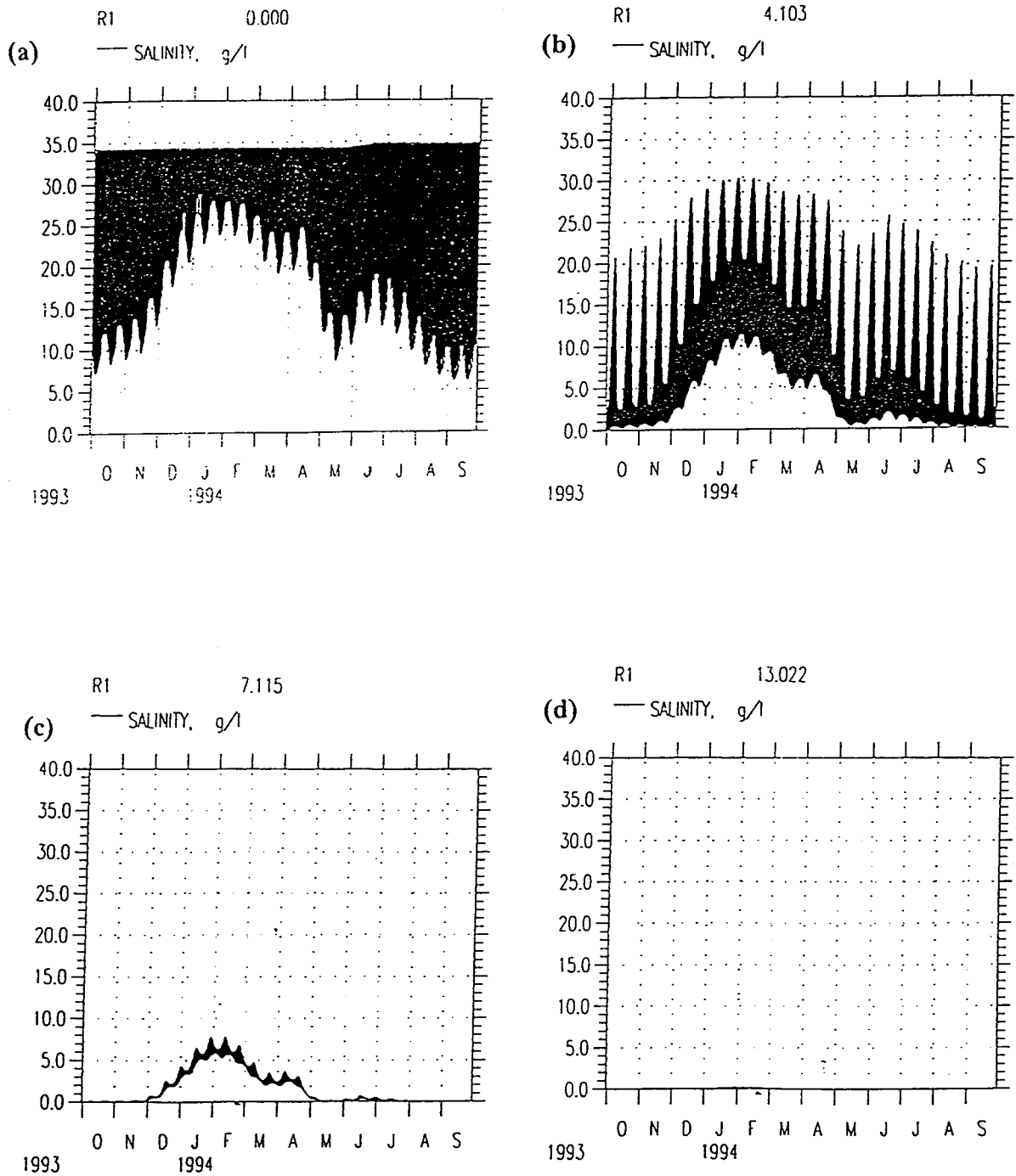

Figure 4.2 Mike 11 predictions under the natural run-off scenario at the mouth (a), in the middle reaches (b & c) and in the upper reaches (d).

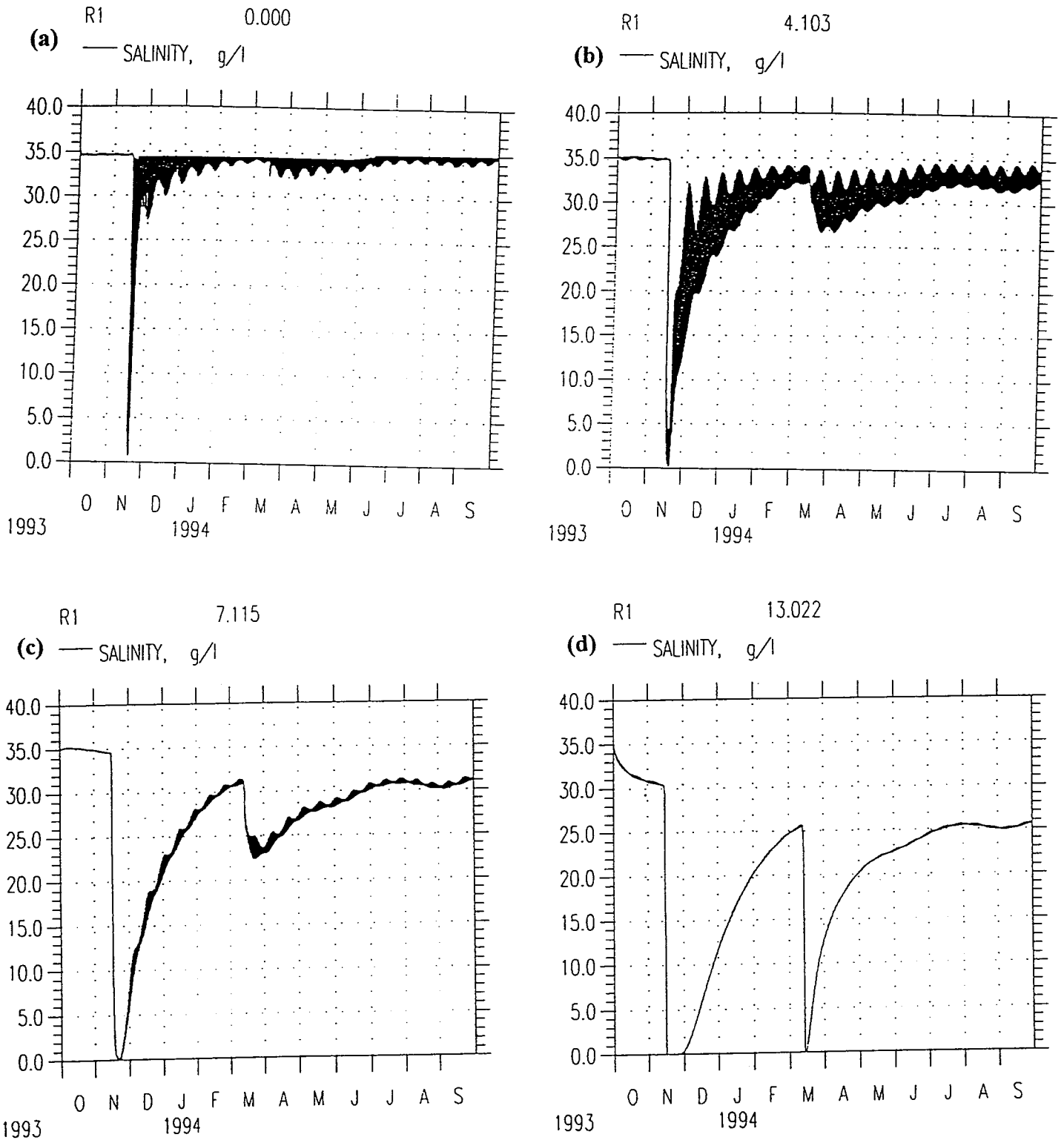

Figure 4.3 Mike 11 predictions under the intermediate run-off scenario 2 at the mouth (a), in the middle reaches (b & c) and in the upper reaches (d).

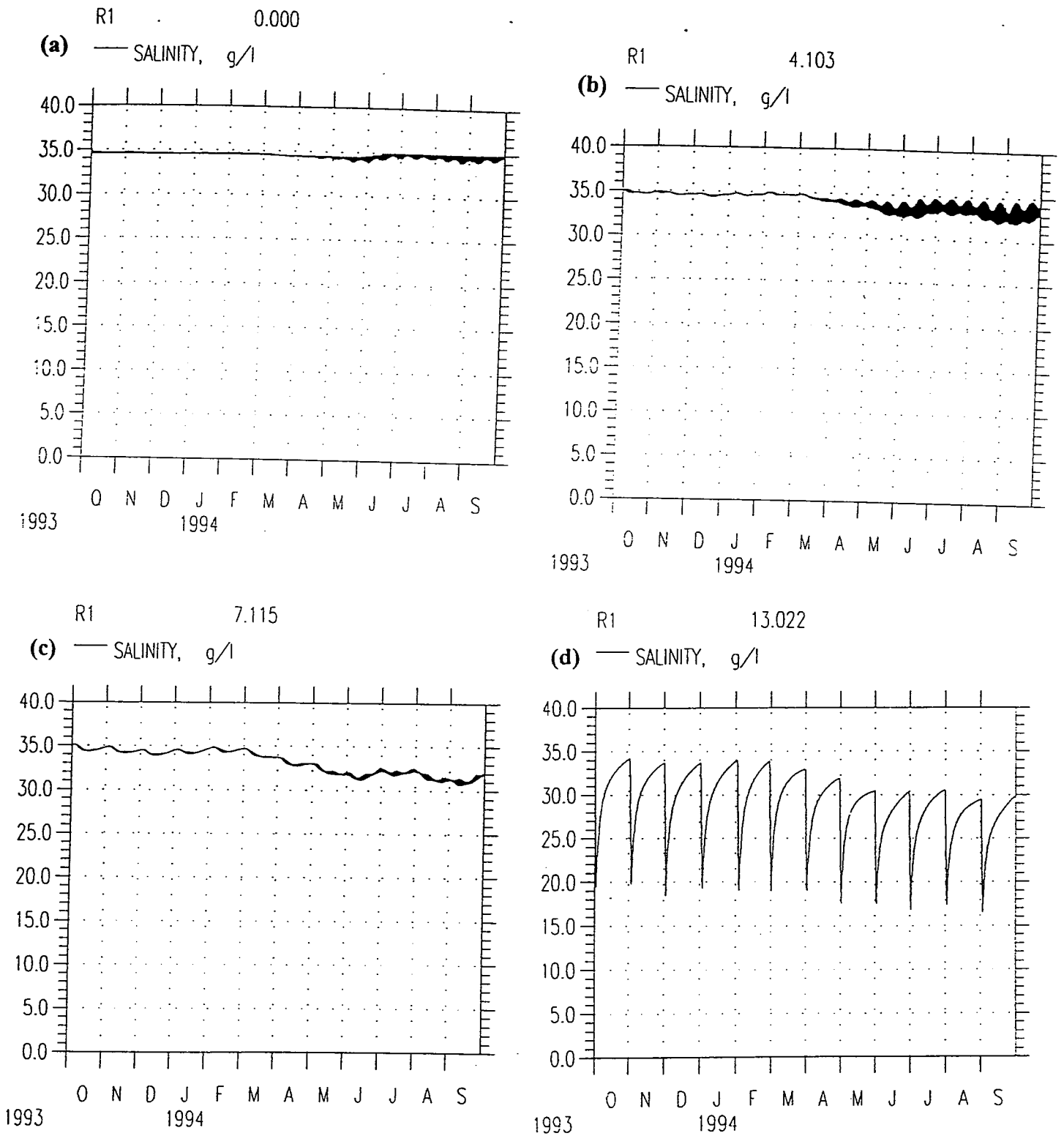

Figure 4.4 Mike 11 predictions under the present run-off scenario at the mouth (a), in the middle reaches (b & c) and in the upper reaches (d).

exhibit minima ranging from 11 ppt to 23 ppt, while the lower reaches remain relatively saline with salinities ranging from 25 ppt to 33 ppt (Figure 4.5). The effect of the flood is temporary in the lower reaches with salinities returning to values near those of sea water within two and a half months, but is more sustained in the upper reaches where salinities above 25 ppt only occur after one and a half months and salinities greater than 30 ppt after two and a half months. Salinities remain at or near sea salinities throughout the estuary for the rest of the year, but hypersalinites are not predicted.

(b) Two releases of equal volume per year (early summer and six months later)

When the first release reaches the estuary in mid November, salinities at the head of the estuary decrease from slightly hypersaline conditions to zero, but the upper reaches are not flushed with freshwater. Upstream of the Geelhoutboom River, salinities greater than 20 ppt persist. Salinities of the middle and upper reaches decline to minima of 25,5 ppt and 29 ppt, respectively (Figure 4.6). The effect of the flood is short-lived with salinities in the lower reaches increasing to those of seawater by the end of January, while the middle reaches have salinities greater than 30 ppt by the end of December. Hypersalinites in the middle and upper reaches are predicted to occur in March and April under the assumed mean evaporation and rainfall rates. However, the arrival of the next freshwater release on 15 May, causes salinities to decrease in the estuary. The effect of this release, while similar to the previous release, lasts slightly longer because of the reduction in evaporation during the winter months.

(c) Two releases of equal volume per year (early summer and four months later)

The effect of the first release is exactly as described for the previous scenario and by the time the second release arrives on 15 March, the middle and upper reaches are exhibiting slight hypersalinites. This effect is curtailed by the influx of freshwater and hypersalinites do not occur throughout the rest of the year. The effect of the second release persists more than the first, because of reduced evaporation in the winter months (Figure 4.7).

(d) Three releases per year (larger release in early summer, 2 smaller releases later, but not in winter)

The effect of the first release is the same as described in the previous two scenarios apart from the fact that a small release of freshwater reaches the estuary on 15 January. This influx of freshwater reduces salinities in the upper reaches from greater than 30 ppt to 16 ppt and less (Figure 4.8). Salinities in the middle reaches are also reduced and are barely approaching sea salinities when the next release reaches the estuary. This causes salinities to decline once more and the effect of reduced evaporation in winter means that salinities do not exceed sea salinity for the rest of the year.

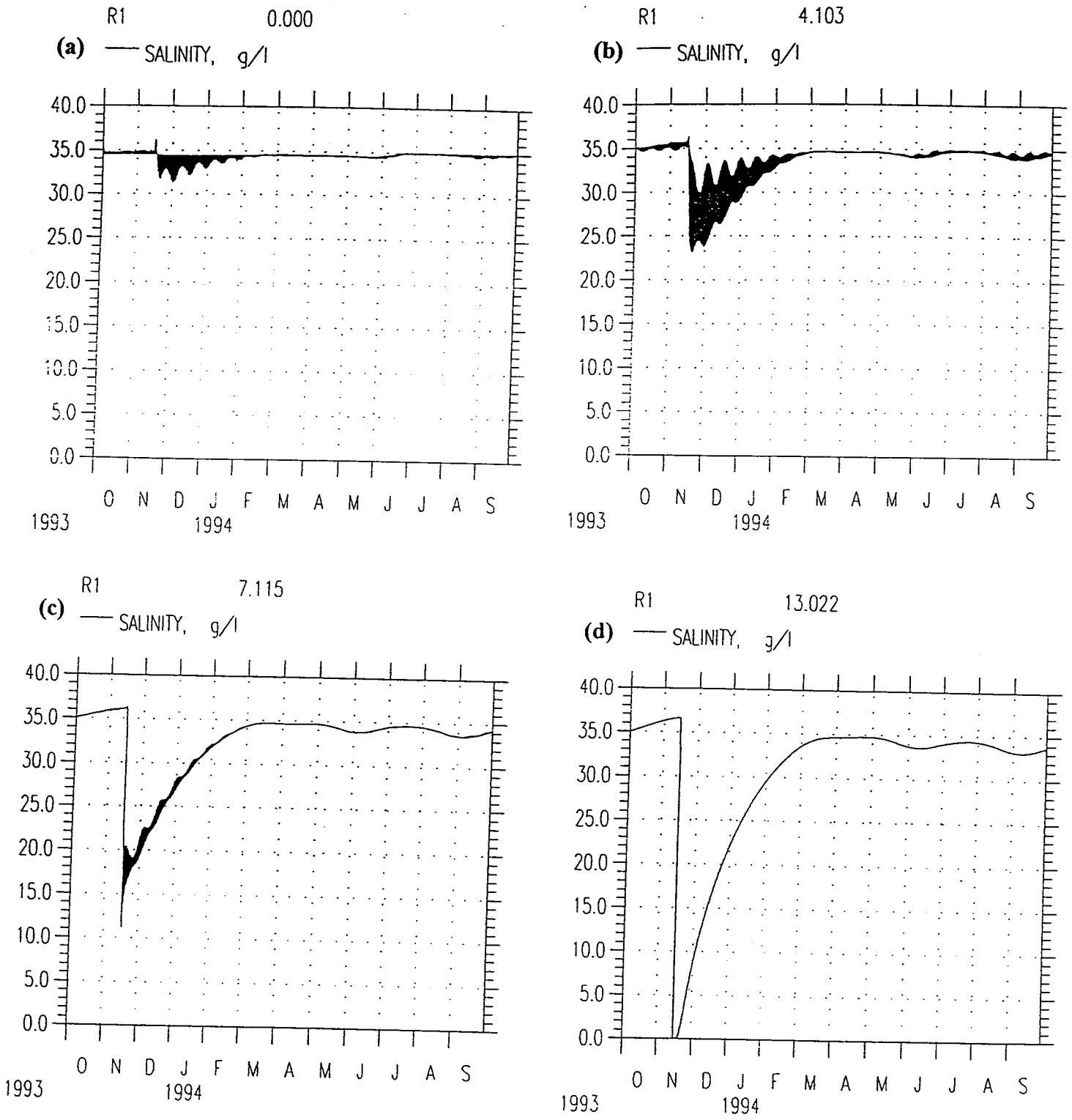

Figure 4.5 Mike 11 predictions under run-off scenario 4a at the mouth (a), in the middle reaches (b & c) and in the upper reaches (d).

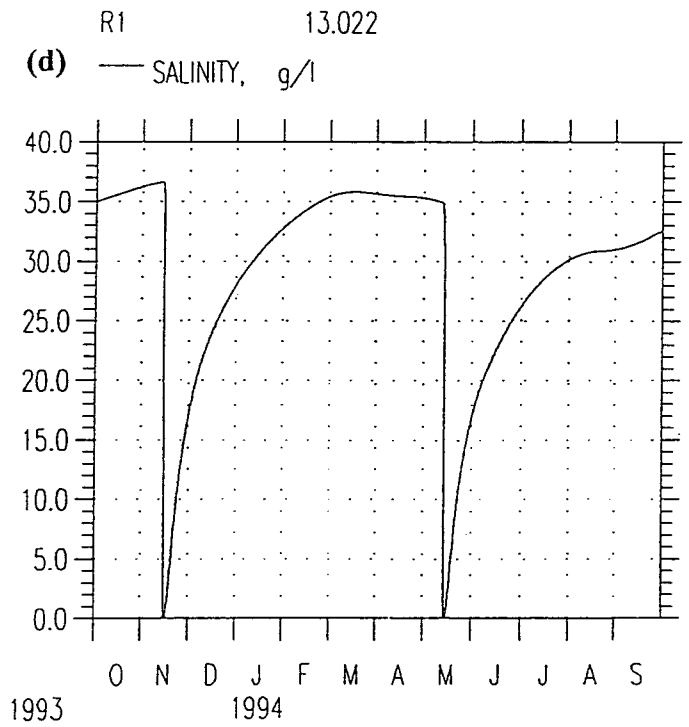
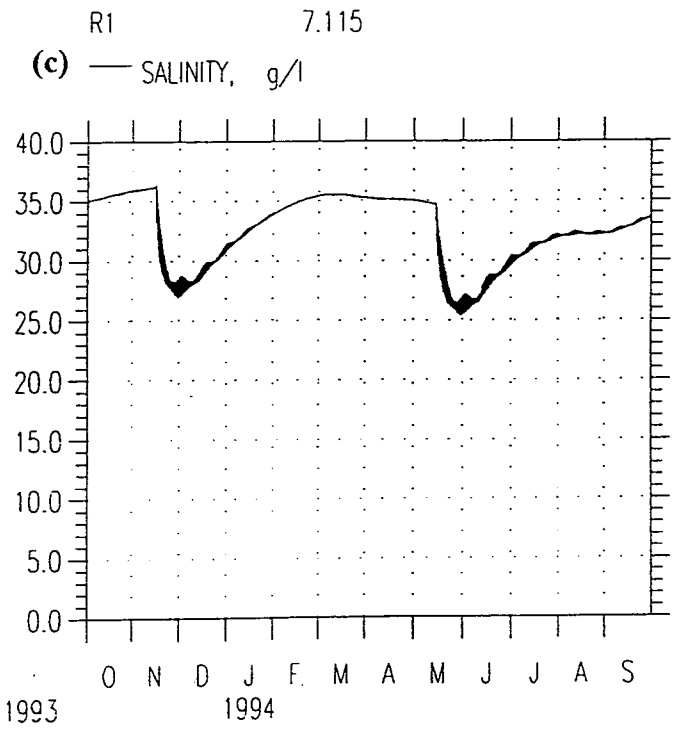
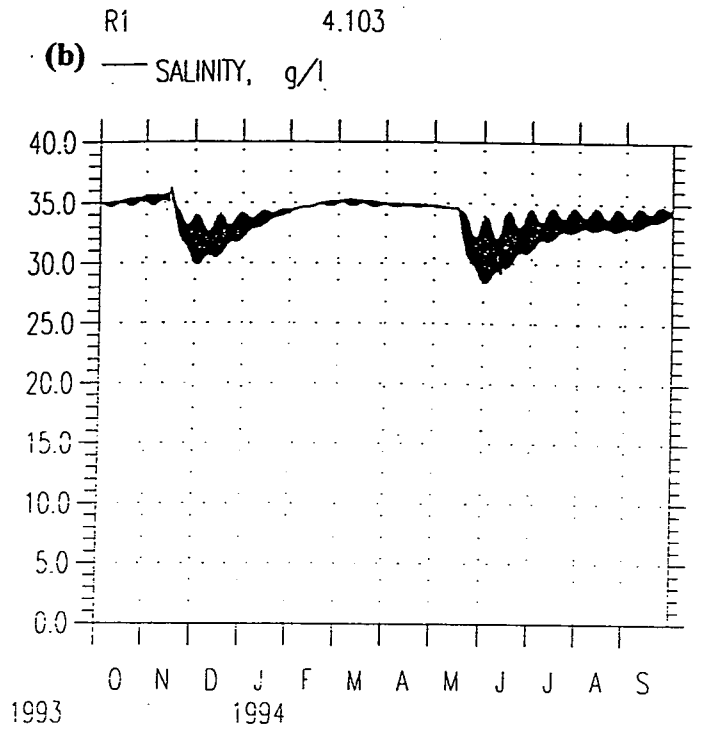
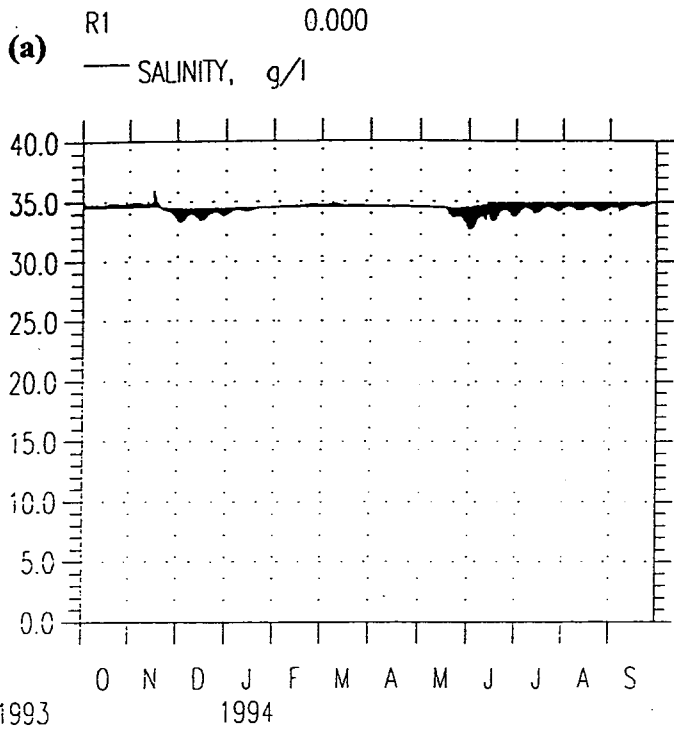

Figure 4.6 Mike 11 predictions under run-off scenario 4b at the mouth (a), in the middle reaches (b & c) and in the upper reaches (d).

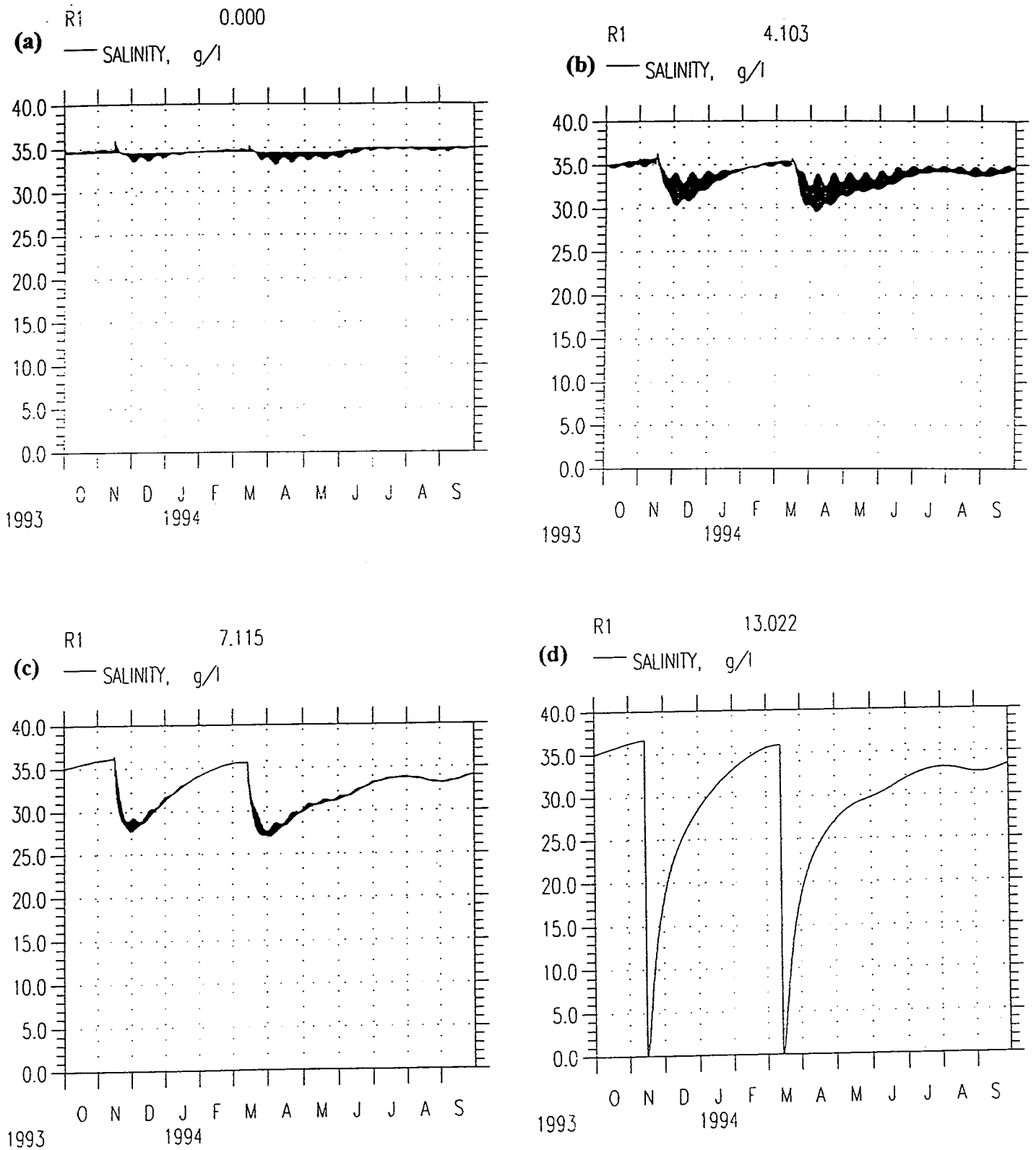

Figure 4.7 Mike 11 predictions under run-off scenario 4c at the mouth (a), in the middle reaches (b & c) and in the upper reaches (d).

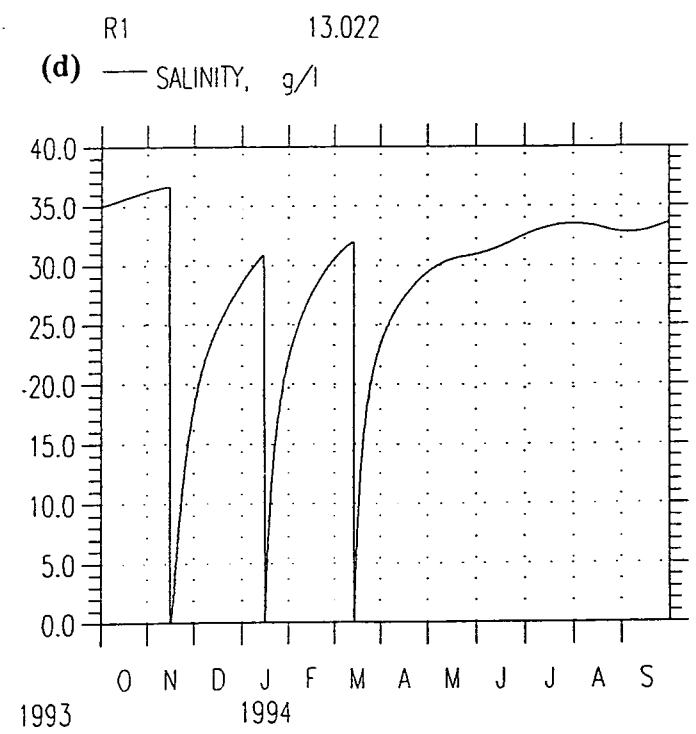
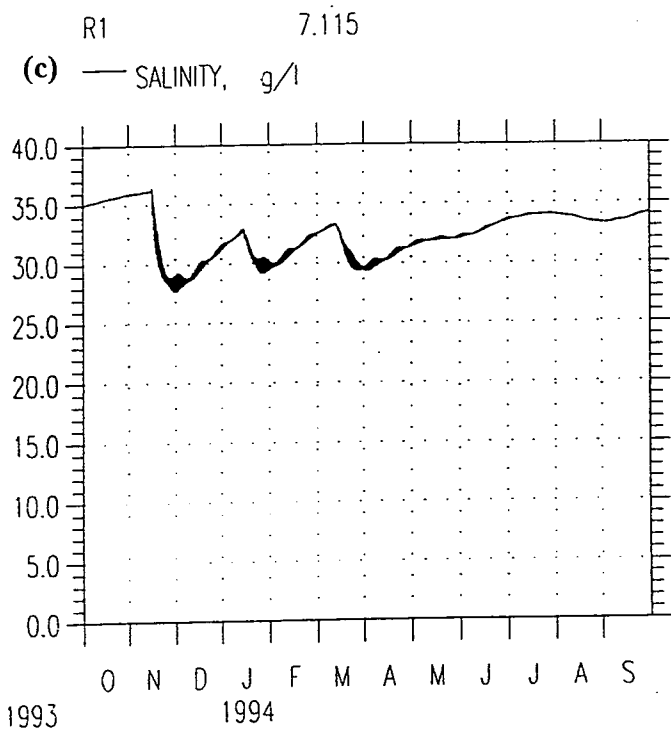
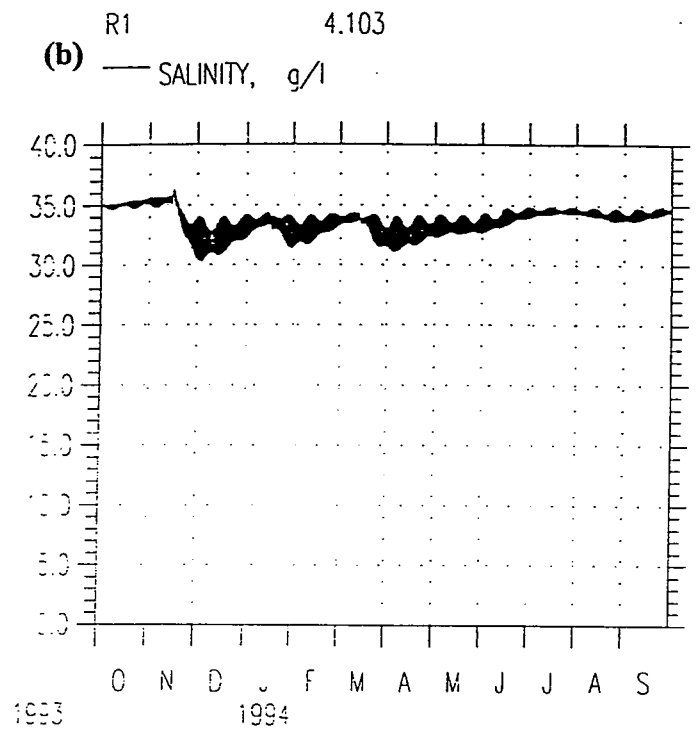
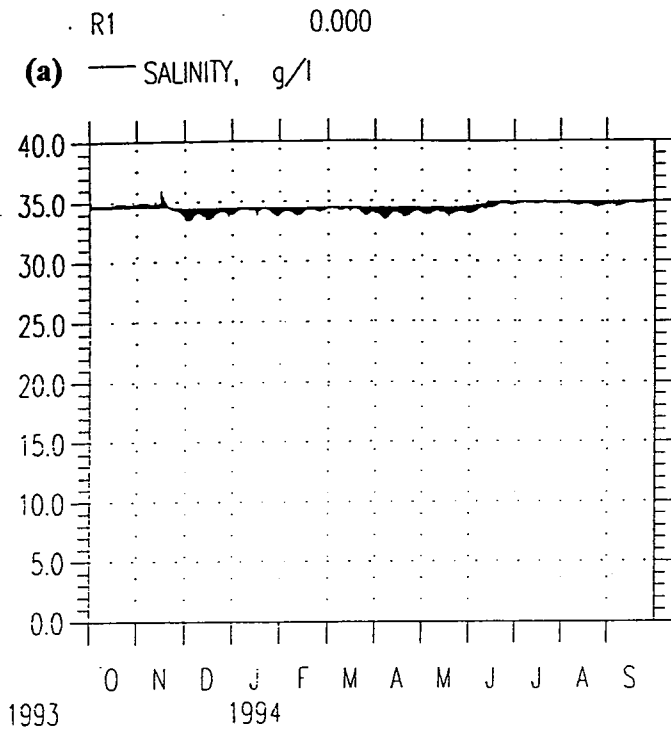

Figure 4.8 Mike 11 predictions under run-off scenario 4d at the mouth (a), in the middle reaches (b & c) and in the upper reaches (d).

5. *No freshwater releases*

Hypersalinities occur in the estuary within one month of the initiation of the simulation. These persist for about eight months before the lower net evaporation rate of the winter months and the diluting influence of sea water ensure that salinities decrease to 35 ppt and less (Figure 4.9). The highest salinities predicted are about 38,5 ppt and these are attained in the upper reaches of the estuary towards the end of February.

6. *The intermediate run-off scenario (20% of the natural MAR)*

The difference between this scenario and that of the intermediate run-off scenario 2 lies primarily in the base flow. This is evident in Figure 4.10, where the salinities in the upper reaches decline sharply from the initial condition of sea water throughout the estuary to remain below 20 from 15 November onwards. Clearly, the 1 in 2 year flood on the 15 November, flushes the estuary with freshwater. While brackish water (< 5 ppt) persists at the head of the estuary for about 45 days, the effect of the flood is less persistent at the mouth and salinities vary between 27 and 34,5 ppt with the tide by the end of November. In the middle reaches salinities vary between 5 and 20 ppt by the end of November and by March lie in the range 21 to 33 ppt, whereas at the head of the estuary 8 ppt is only attained in March. When the late summer release reaches the estuary on 15 March, salinities at the head of the estuary decrease to zero and salinities in the middle reaches decrease to between 5 and 13 ppt. Salinities at the mouth decrease to 21 ppt, but the effect is temporary. By the end of June, the salinities of the middle reaches are 18 ppt and greater and the upper reaches have salinities varying between 7 and 20 ppt. This situation persists for the rest of the year.

7. *The intermediate run-off scenario (40% of the natural MAR)*

The differences between this scenario and the other intermediate run-off scenarios lies primarily in the base flow components. Under the 40% MAR situation, the head of the estuary has salinities of 1 ppt and less, once the effect of the initial condition for the simulation is negated. After 15 November, the upper reaches generally exhibit salinities less than 8 ppt, the middle reaches have salinities ranging between 7 ppt and 30 ppt when no floods are occurring, but these decrease to below 3 ppt throughout under flood conditions (Figure 4.11). The lower reaches of the estuary have salinities ranging from that of sea water to about 24 ppt under normal tidal conditions, but these decrease to below 21 ppt under flood conditions. The physical environment of the estuary is most similar to the natural run-off condition under this scenario than under any of the others. There is a strong backish component to the estuary (the upper reaches), a transitional zone (the middle reaches) and a more marine dominated area (the lower reaches).

Disturbance scenarios

The most likely perturbation to an annual water allocation policy in the Eastern Cape region is the occurrence of a drought. For this reason, the disturbance scenarios selected represent the omission of freshwater flow to the estuary for different time periods:

A. *No freshwater flow to the estuary for one year*

Instead of taking the final conditions of each of the seven scenarios described above and simulating no freshwater flow from that point for a full year, it was considered that patching the simulation results from scenario 5 onto this final condition would suffice to represent disturbance scenario A.

B. *No freshwater flow to the estuary for three consecutive years.*

Following the logic explained above, it then remained to simulate the situation resulting from no freshwater flow for a period of 3 years. This could then be patched onto other scenarios for analysis of the effects of perturbations on the dynamic equilibrium resulting from imposition of the different inflow scenarios. This simulation is also termed scenario 8. Hypersalinities occur during the late summer/early autumn period (March, April) each year. The maximum salinity values predicted are about 39 ppt (Figure 4.12).

Model Limitations and Range of Applicability

Mike 11 is a one dimensional model and consequently does not account for the effects of vertical salinity differences on water exchange and movement. In the event of a pulse of freshwater entering a saline water body, these effects could well be significant. Freshwater is less dense than seawater, unless the temperature of the freshwater is considerably lower than the saline water. Assuming that this is not the case, the buoyant freshwater would tend to override the saline estuarine water and flow seaward predominantly on the surface. If this were to occur in the Kromme Estuary, the head of the estuary would still be flushed by freshwater, but the water column of the middle reaches might exhibit intense stratification. The location in the estuary at which a saline wedge of water would persist at the base of the estuary is difficult to predict and is certainly beyond the capability of a one dimensional model. If such strong stratification were to occur, it is likely that the longitudinal salinity gradient would be more intense, perhaps enhancing faunal cueing and improving ichthyofaunal and invertebrate migration.

Because the accuracy of the evaporation rates and rainfall rates used in the Mike 11 simulations is not good, the hypersalinities predicted in the scenarios must be considered indications of the likelihood of occurrence of such conditions rather than the actual values that would occur. If the reliability and detail of the input data were to improve, the reliability of these predictions would improve.

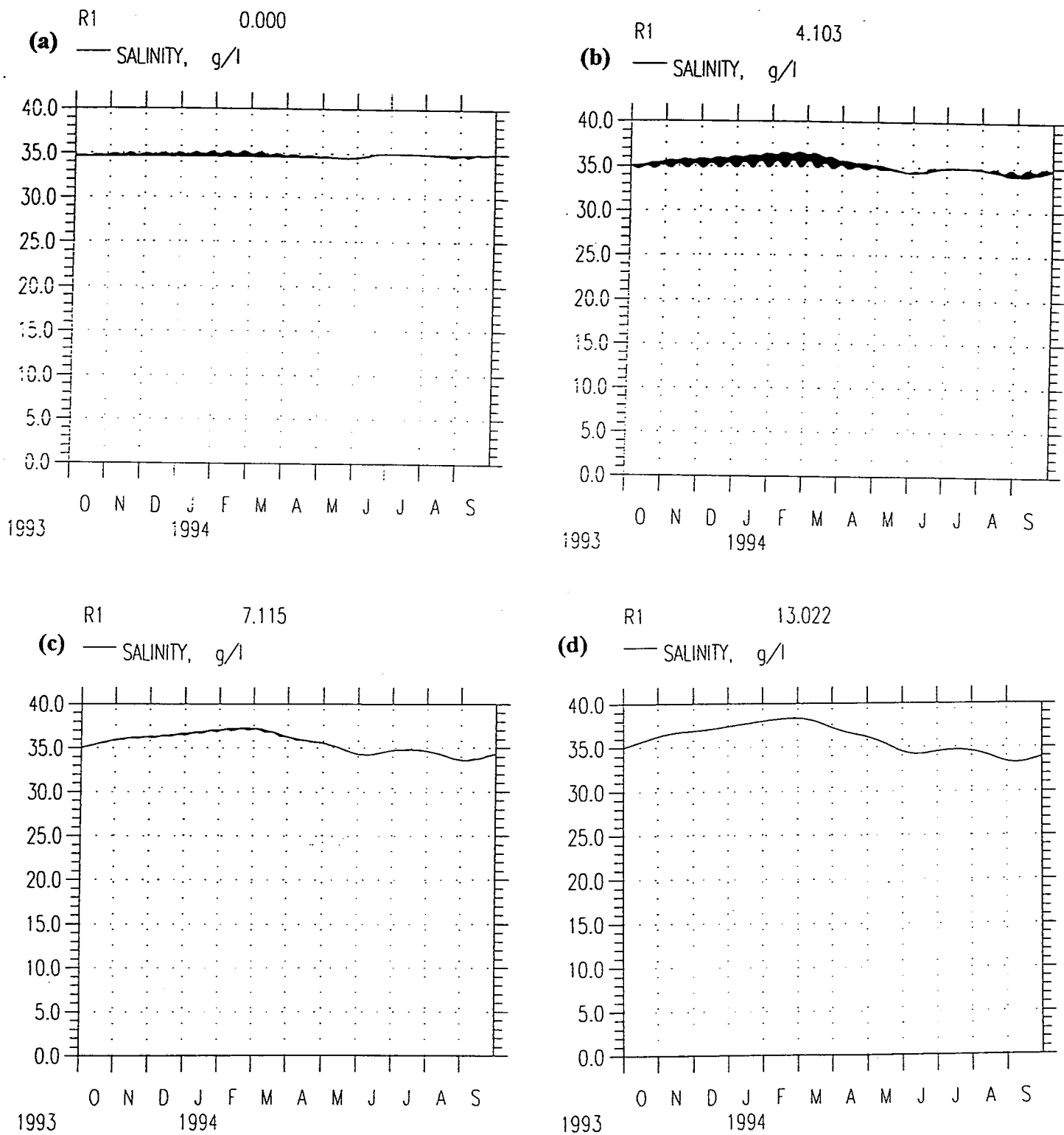

Figure 4.9 Mike 11 predictions under run-off scenario 5 at the mouth (a), in the middle reaches (b & c) and in the upper reaches (d).

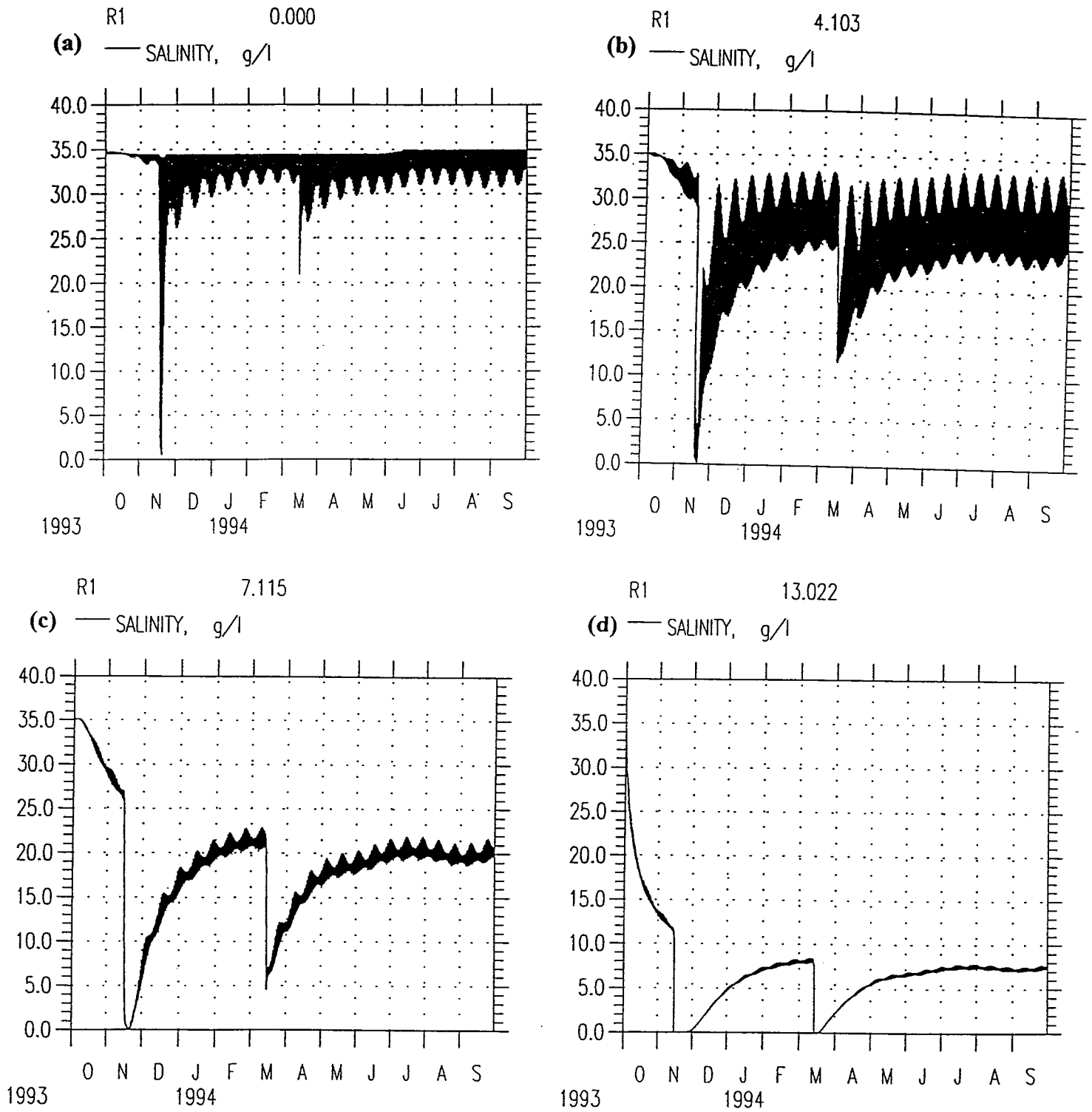

Figure 4.10 Mike 11 predictions under run-off scenario 6 at the mouth (a), in the middle reaches (b & c) and in the upper reaches (d).

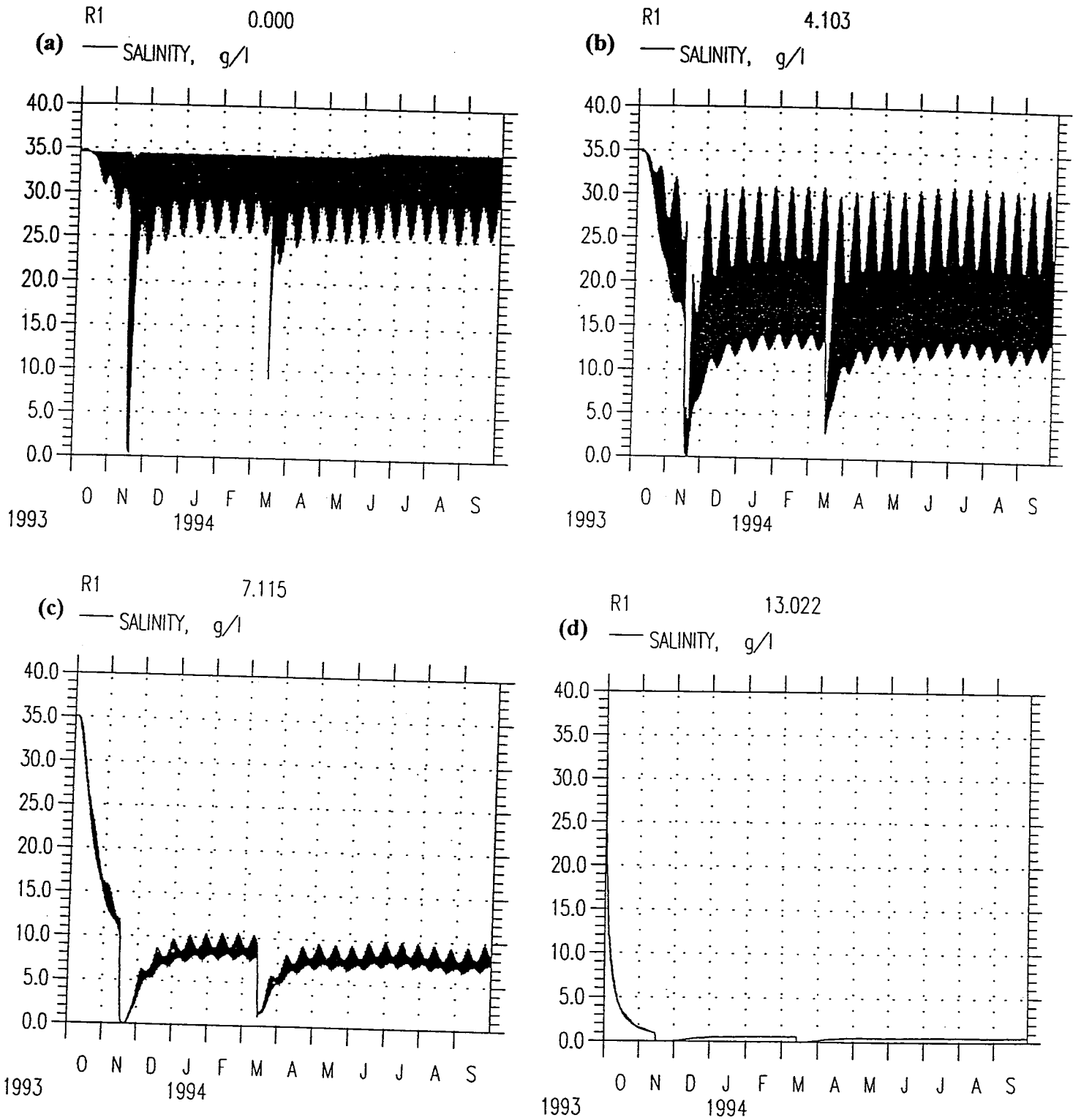

Figure 4.11 Mike 11 predictions under run-off scenario 7 at the mouth (a), in the middle reaches (b & c) and in the upper reaches (d).

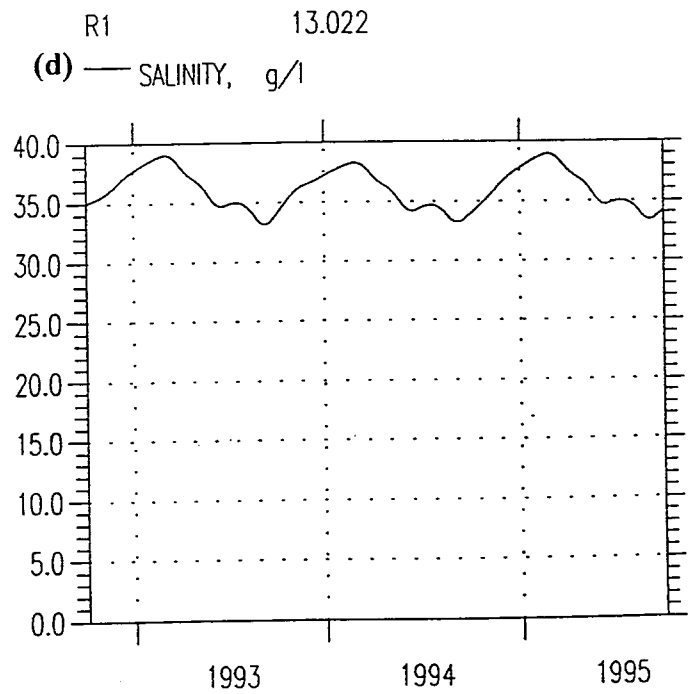
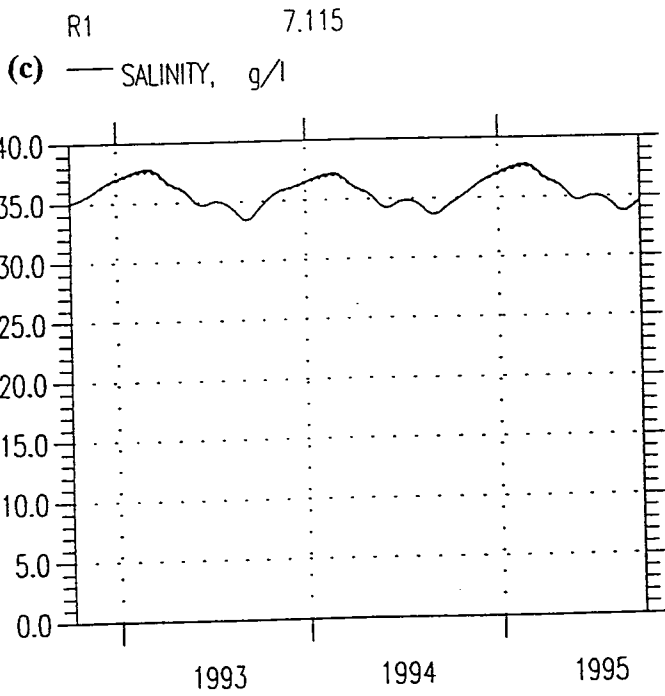
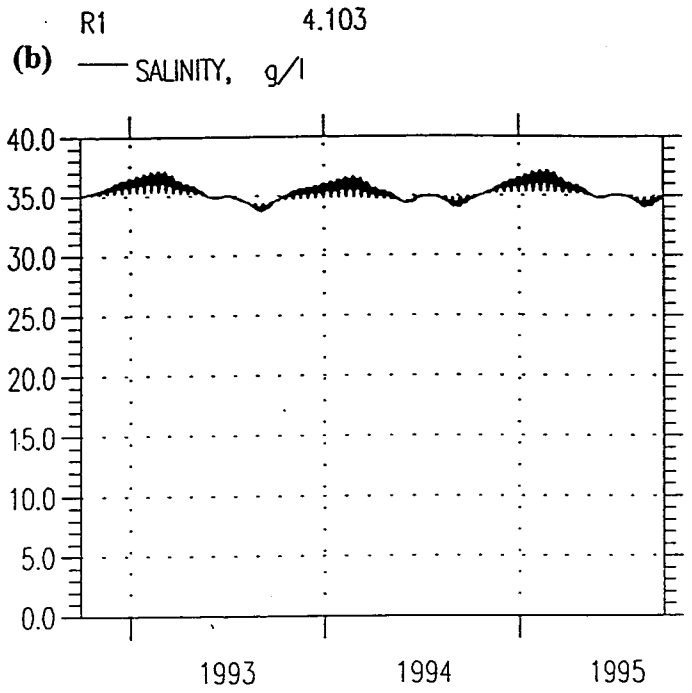
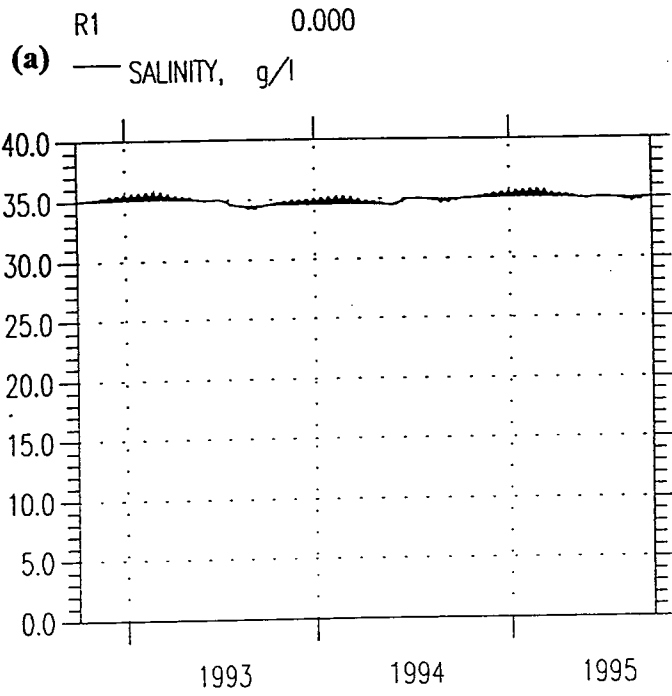

Figure 4.12 Mike 11 predictions under run-off scenario 8 at the mouth (a), in the middle reaches (b & c) and in the upper reaches (d).

The output data supplied to all the other models or predictive techniques by Mike 11 comprised daily minimum and maximum water levels, tidal range, average salinity and maximum current velocity data for 5 positions in the estuary (Figure 4.1).

4.3.2 The Mike 11 Water Quality Module

Information on dissolved oxygen and dissolved nutrient concentrations in the Kromme Estuary are fairly limited, although the majority of the data available from the literature are summarised in Bickerton & Pierce (1988) and data of more recent date have been collated by Ms U Scharler of the Zoology Department of the University of Port Elizabeth. However, two trial simulations of the coupled BOD-DO module of Mike 11, incorporating interaction with the estuary bed, were undertaken using a number of default chemical reaction parameters. Both simulations cover a period of one week and relate to a dry season condition of no freshwater inflow. In the first, a natural sediment oxygen demand of $1 \text{ gO}_2 \cdot \text{m}^{-2} \cdot \text{day}^{-1}$ is assumed, whereas the sediment oxygen demand of the second is set at $0,2 \text{ gO}_2 \cdot \text{m}^{-2} \cdot \text{day}^{-1}$. In accord with the actions of Dr A Ramm in undertaking the trial application of the Mike 11 water quality module to the Great Brak Estuary, the following assumptions were made regarding other parameter values and the boundary conditions:

- the dissolved oxygen concentration of the sea is set at $7 \text{ mg} \cdot \text{l}^{-1}$ throughout the simulation,
- a closed boundary is assumed at the head of tidal influence,
- the BOD first order decay parameter (k_1) is set at 0,2 throughout the estuary, and
- the re-aeration formula of O'Connor-Dubbins was selected.

The simulation results are presented in Figures 4.13a and 4.13b. In these diagrams the profile of cross-sections extending from the mouth to 14 km upstream (the head of the estuary) is illustrated. Overlaid on this profile are the curves representing the longitudinal variations in the depth-averaged dissolved oxygen concentrations. The following features may be observed:

- Both simulations exhibit a peak in oxygen concentrations about 5 km upstream of the mouth. This corresponds to the shallowest area in the estuary. Enhanced mixing occurs here particularly on the flood tide when intruding water plunges over the edge of the sand bank, which lies diagonally across the channel, and flows slowly into the deep channel beyond. This causes the well oxygenated and actively exchanging water in this region to experience significantly higher re-aeration.
- Figure 4.13a indicates that with a BOD first order decay co-efficient of 0,2 and a relatively high SOD of $1 \text{ gO}_2 \cdot \text{m}^{-2} \cdot \text{day}^{-1}$, dissolved oxygen concentrations of less than $6 \text{ mg} \cdot \text{l}^{-1}$ would occur in the middle reaches under conditions of no freshwater inflow, while DO concentrations of $3 \text{ mg} \cdot \text{l}^{-1}$ would occur at the head of the estuary. Figure 4.13b exhibits the same trend, but the oxygen concentrations remain above $4 \text{ mg} \cdot \text{l}^{-1}$ throughout the estuary.

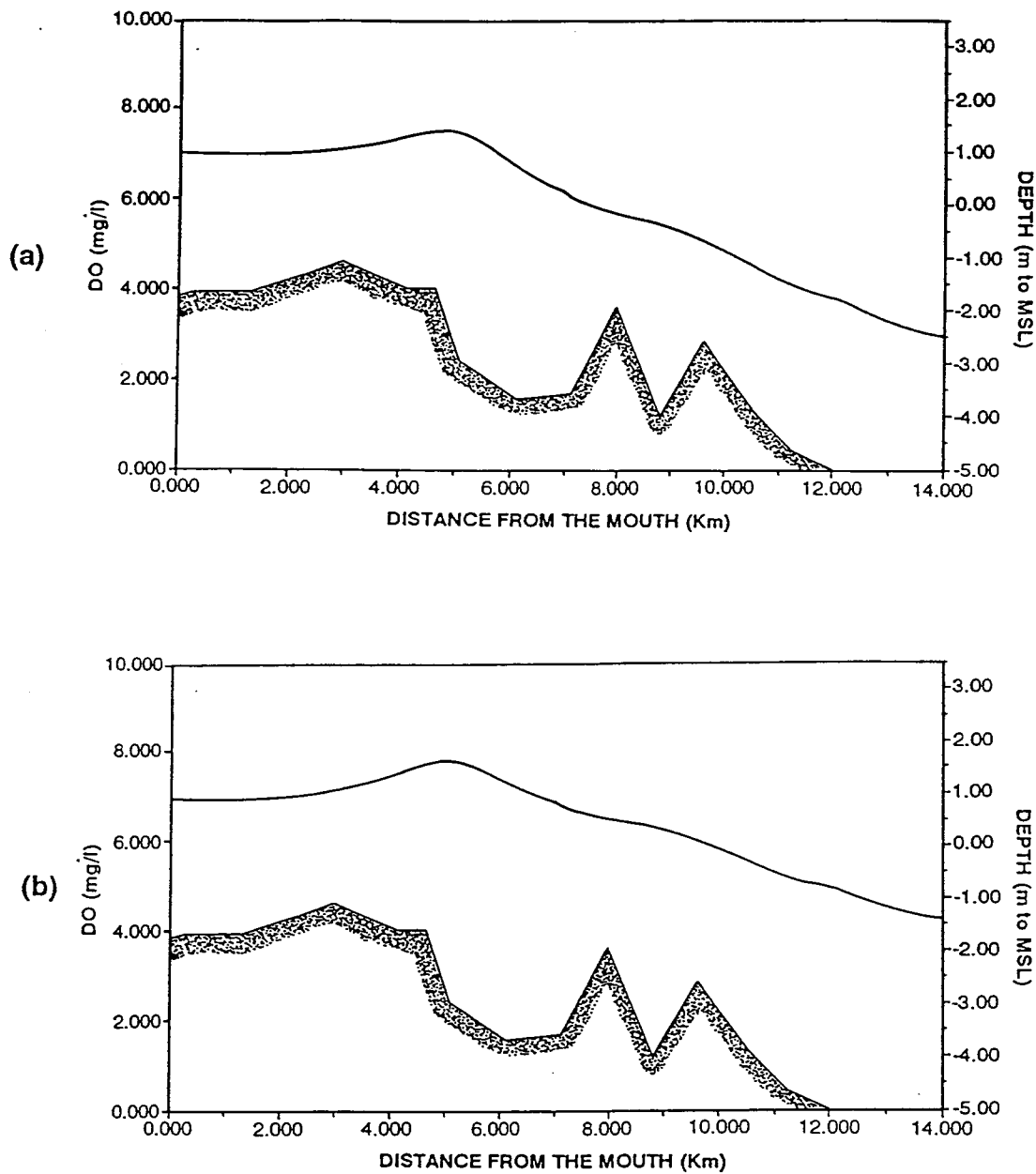

Figure 4.13 Average vertical dissolved oxygen concentrations simulated in the Kromme Estuary after a week of no freshwater inflow. The parameter value for BOD first order decay (k_1) is set at $k_1 = 0,2$ and the value of sediment oxygen demand (SOD) is set at $1 \text{ gO}_2 \cdot \text{m}^{-2} \cdot \text{day}^{-1}$ for (a) and $0,2 \text{ gO}_2 \cdot \text{m}^{-2} \cdot \text{day}^{-1}$ for (b).

The decline in oxygen in the middle and upper reaches cannot be ascribed to gradually increasing salinities in these reaches, because the initial condition for salinity assumed sea water throughout. Similarly water of temperature 20°C was assumed at the outset. As the DO values given in the literature do not indicate hypoxic conditions to be a common occurrence in the Kromme Estuary (and the well mixed state of the water column would bear this out), the assumed natural sediment oxygen demand and the value of the first order decay co-efficient for BOD are clearly too high. These simulations, therefore, are not considered reflective of reality for the Kromme Estuary.

Any practical application of the water quality module would have to involve field work to determine the BOD and SOD rates more accurately, while a diurnal DO study is required to ascertain the rates at which photosynthesis, respiration and re-aeration are occurring. Additionally, the influence of deviations in the temperatures of the sea and river from the default parameters assumed in the model could be investigated as could the effect of wind in enhancing re-aeration. These factors can play a major role in causing seasonal variations in the dissolved oxygen concentrations of an estuary. Provided the necessary field work is undertaken, no problems are foreseen in the application of the Mike 11 water quality module to the Kromme Estuary particularly in view of the vertically mixed state of the water column which means that the dissolved oxygen concentrations predicted by the model are more likely to accord with those measured in reality than in the case of a stratified estuary.

4.3.3 The Plant Estuarine Decision Support System (PEDSSys)

Information Required by the Expert System PEDSSys

A SELECT PLANTS PRESENT:

Emergent macrophytes:

Phragmites australis, *Scirpus maritimus*

Salt marsh macrophytes:

Juncus kraussii, *Salicornia* spp., *Sarcocornia perennis*, *Spartina maritima*, *Sporobolus virginicus*, *Triglochin* spp.

Submerged macrophytes:

Potamogeton pectinatus, *Ruppia cirrhosa*, *Zostera capensis*.

Phytoplankton:

Diatoms, dinoflagellates

Benthic microalgae

B QUESTIONS FOR SUBMERGED MACROPHYTES

Choose which water level applies:

- increased to 2.5 m or more
- increased, but < 2.5 m
- decreased without exposure
- decreased with exposure, sediment remains saturated
- decreased with exposure, sediment drying out

Turbidity: high/medium/low

Water velocity (m.s^{-1}) ?

Salinity (ppt) ?

Salinity will be maintained for (days) ?

Sediment will remain saturated for (days) ?

Pollution is present: no/yes

C QUESTIONS FOR SALT MARSH AND EMERGENT MACROPHYTES

Choose which water level applies:

- risen to cover > 75% of plant
- risen to cover 50-75% of plant
- risen to cover < 25% of plant
- dropped, but sediment remains saturated
- dropped and sediment is drying out

Season: autumn/winter/spring/summer

Plants will remain covered for (days) ?

Salinity (ppt.) ?

Salinity will be maintained for (days) ?

Sediment will remain dry for how many days ?

Pollution is present: yes/no

D QUESTIONS FOR PHYTOPLANKTON (DIATOMS AND DINOFLAGELLATES) AND BENTHIC MICROALGAE

The sediment is: sand/silt/mud

Nitrate ($\mu\text{g/l}$) ?

Salinity: bottom (> 0.5 m water depth)
top (< 0.5 m water depth)
mouth
middle
head

The salinity will remain for (days) ?

Application of PEDSSys

The form of the results provided by PEDSSys for the estuarine macrophytes is a growth rate adjustment score with a range of -10 to +10, where 0 means the plants will be unaffected and there is no change in growth rate, a positive score means that the growth rate will increase, a negative score means that the growth rate will decrease and a score of -10 means that the plants will die.

The following estuarine macrophytes were considered in the application of PEDSSys to the Kromme Estuary:

- submerged macrophyte (<0.75 m + MSL): *Zostera capensis*,
- saltmarsh plant (> 0.75 m + MSL): *Sarcocornia perennis*, and
- emergent reed (> 0.75 m + MSL): *Phragmites australis*.

Zostera capensis is a seagrass that occupies the intertidal and shallow subtidal zone in South African estuaries. It is dominant in permanently open tidal estuaries because of its ability to survive daily periods of exposure (Adams and Bate 1994a). Submerged macrophyte communities are important as they provide a substantial amount of primary productivity, nutrient storage and nursery habitats in shallow estuarine waters. *Zostera* thrives under saline conditions (35 ppt). It can survive under freshwater conditions (eg. Lake St Lucia) but biomass and bed density is reduced with the passage of time.

A number of different *Sarcocornia* species are found in South African estuaries. *Sarcocornia perennis* is an important component of salt marshes that occurs in the lower intertidal zone. It is a succulent plant that forms mats up to 25 cm high. In surveys of a number of South African estuaries, *Sarcocornia* was found in areas where the salinity ranged from 12 to 42 ppt. *Sarcocornia* is sensitive to changes in water level, and, after 2 weeks submergence, growth of the plants is already reduced (Adams and Bate 1994b).

The common reed, *Phragmites australis*, is a ubiquitous species that forms monospecific stands in wet habitats. In South African estuaries, *Phragmites* forms dense beds in the brackish upper reaches and is also found at the confluence of small freshwater streams and seepage areas flowing into the estuary. Optimal growth of *Phragmites* occurs where the salinity is less than 15 ppt (Adams and Bate 1994c).

Although Mike 11 data was supplied for station positions at the mouth of the estuary and at several positions upstream of the mouth, PEDSSys predictions were made for only three representative sites in the Kromme Estuary. A nominal site 1 was taken as the mouth of the estuary, site 2 is located 3,1 km from the mouth in the lower reaches, site 3 at 5,1 km from the

mouth in the middle reaches and site 4 at 10,1 km from the mouth in the upper reaches. The questions posed by the expert system were answered for the selected estuarine macrophytes using the physical environmental data provided by Mike 11 for each scenario, particularly the mean salinity, maximum current velocity and maximum and minimum water levels.

Turbidity was considered to be low for all scenarios except the natural run-off scenario (Scenario 1). Turbidity is expressed as high, medium or low in the expert system. This parameter needs to be quantified more accurately as actual secchi disc or irradiance ($\mu\text{mol}\cdot\text{m}^{-2}\cdot\text{s}^{-1}$) readings.

Current velocity did not change much for the different scenarios (Tables 2 and 3). Submerged macrophytes will not persist in estuaries where the current velocity consistently exceeds 1 m s^{-1} (which would represent high flow conditions in most South African estuaries) and at 0.5 m s^{-1} growth would be significantly reduced. For most of the scenarios current velocities were less than 0.1 m s^{-1} . Under these conditions submerged macrophytes would grow and become well established. The mouth of the Kromme estuary remained permanently open and so water level fluctuations were similar under the different run-off scenarios. No significant changes in the estuarine plants, therefore, are predicted owing to differences in the water level variations from one run-off scenario to another. A comparison of the water velocity and water level data for the two extreme scenarios, the pre-development scenario (Table 2) and the no freshwater release scenario (Table 3) shows that there is very little difference in these aspects of the physical data.

Table 2 Current velocities and water levels at various sites under the natural run-off scenario. These data were obtained from Mike 11.

SITE NUMBER	Velocity (m s^{-1})		Water level (m to MSL)	
	maximum in	maximum out	maximum	minimum
1	0.27	-0.28	0.96	0.16
2	0.34	-0.29	0.93	0.26
3	0.16	-0.12	0.95	0.29
4	0.03	-0.04	0.99	0.24

Salinity values varied for the different run-off scenarios (Table 4). Mean salinity values show that conditions were brackish under the natural run-off scenario. For the no freshwater release scenario a longitudinal salinity gradient was absent and salinities were high (35ppt).

Table 3 Current velocities and water levels at various sites under the no freshwater release scenario. These data were obtained from Mike 11.

SITE NUMBER	Velocity (m s ⁻¹)		Water level (m to MSL)	
	maximum in	maximum out	maximum	minimum
1	0.28	-0.27	0.96	0.15
2	0.36	-0.28	0.92	0.24
3	0.18	-0.11	0.93	0.25
4	0.04	-0.08	1.02	0.23

Table 4 Mean salinities under the different run-off scenarios. These data were obtained from Mike 11.

RUN-OFF SCENARIOS	LOWER REACHES	MIDDLE REACHES	UPPER REACHES
Natural run-off scenario	17	8	0
Intermediate scenario, 10 % MAR	31	29	23
Intermediate scenario, 20 % MAR	27	23	12
Intermediate scenario, 40 % MAR	21	14	3
No freshwater release	35	35	36

The response of the estuarine flora to the different run-off scenarios.

Zostera capensis

Zostera growth rate adjustment scores were negative for the middle and upper reaches for the natural run-off scenario and also for the upper reaches for the intermediate run-off scenario (40 % MAR). Prolonged fresh or brackish conditions cause die-back of this salt-loving plant. If there is a longitudinal salinity gradient in the estuary then *Zostera* would occur in the lower and middle reaches and other submerged macrophytes such as *Ruppia cirrhosa* and *Potamogeton pectinatus* would occur in the freshwater/brackish upper reaches. A longitudinal salinity gradient is, therefore, important if macrophyte diversity is to be maintained.

All scenarios, except the natural run-off scenario, have higher growth rate adjustment scores for *Zostera* in the middle estuarine reaches compared with the lower reaches. This is attributed to the higher water velocities associated with the mouth region.

The assumption made in predicting the response of *Zostera* is that the turbidity of the estuary is medium for the natural run-off scenario. If the turbidity were low then the growth rate adjustment score for *Zostera* would increase. For example, the growth rate adjustment score for *Zostera* in the lower reaches was 3.6 but if the turbidity were low this would increase to 8.4. For all other scenarios, excluding the natural run-off condition it was assumed that the turbidity was low. In 1979, before the construction of the second dam in the catchment, Hanekom (1979) recorded a secchi disc reading of 0.72 m for the middle reaches, while Hilmer (1989) recorded a value of 1.32 m for the same position. The lack of freshwater input to the estuary has increased the water clarity. *Zostera* flourishes as a result of this as well as the high salinities and low current velocities.

Table 5 Growth rate adjustment scores for the submerged macrophyte *Zostera capensis* in the lower, middle and upper reaches of the estuary.

RUN-OFF SCENARIO	LOWER REACHES	MIDDLE REACHES	UPPER REACHES
Natural run-off	3.6	-9.6	-9.4
Intermediate, 10 % MAR	8.4	10	10
Intermediate, 20 % MAR	8.4	10	10
Intermediate, 40 % MAR	8.4	10	-4.3
No freshwater release	8.4	10	10

Phragmites australis

The growth rate adjustment scores provided by PEDSSys for *Phragmites* indicate optimal growth in the middle and upper reaches under the natural run-off scenario and the intermediate run-off scenario (40 % MAR). The mean salinity of the upper reaches under the intermediate run-off scenario (20 % MAR) was 12 ppt (Table 4), this is within the optimal salinity range for *Phragmites* accounting for the maximum growth rate adjustment score of 10 (Table 6).

Table 6 Growth rate adjustment scores for the emergent reed *Phragmites australis* in the lower, middle and upper reaches of the estuary.

RUN-OFF SCENARIO	LOWER REACHES	MIDDLE REACHES	UPPER REACHES
Natural run-off	0	10	10
Intermediate, 10 % MAR	0	0	0
Intermediate, 20 % MAR	0	0	10
Intermediate, 40 % MAR	0	10	10
No freshwater release	0	0	0

Sarcocornia perennis

Salinity conditions under the natural and intermediate run-off scenarios favoured growth of the saltmarsh plant, *Sarcocornia*. For the no freshwater release scenario growth was unaffected (growth rate adjustment score is 0) as the plant can survive under these salinity conditions (Table 7). Although the plants survive the condition of no freshwater release for one year, prolonged freshwater deprivation may cause salts to accumulate in the marsh sediments, an unfavourable condition .

Table 7 Growth rate adjustment scores for the saltmarsh macrophyte *Sarcocornia perennis* in the lower, middle and upper reaches of the estuary.

RUN-OFF SCENARIO	LOWER REACHES	MIDDLE REACHES	UPPER REACHES
Natural run-off	10	10	10
Intermediate, 10 % MAR	0	10	10
Intermediate, 20 % MAR	10	10	10
Intermediate, 40 % MAR	10	10	10
No freshwater release	0	0	0

The effects of freshwater pulses on the estuarine plants

For the intermediate run-off scenarios the 1-in-2 year flood and freshette reduced salinity. As salinity values fluctuate, the growth rate adjustment score changes for the different plants depending on the optimal range of salinity tolerance for that species (Table 8). Freshwater conditions for 10 days reduces the growth of *Zostera* in the short term, but as the salinity increases the growth rate adjustment score would increase from 2.4 to 10 (Table 8). Although not predicted by PEDSSys, the 1-in-2 year flood may be beneficial to saltmarsh plants as it would wash out salts accumulated in the sediment.

Table 8 The effects of salinity fluctuations on the estuarine plants (Intermediate scenario 10 % MAR, upper reaches).

TIME (days)	30	10	20	60	90	150
SALINITY	34	0	17	20	28	26
<i>Zostera</i>	10	2.4	10	10	10	10
<i>Sarcocornia</i>	3	3.3	10	10	10	10
<i>Phragmites</i>	0	3.3	3.9	1.7	0	0

Disturbance Scenario: no freshwater flow to the estuary for 3 consecutive years

Zostera capensis would grow optimally and have a growth rate adjustment score of 10. The salt marsh plants would be unaffected (growth rate adjustment score 0), but growth of the brackish reed *Phragmites australis* would be reduced.

Model Limitations and Range of Applicability

PEDSSys predicts the response of the plants to water column salinity, which is directly affected by freshwater input. However, factors such as evaporation and accumulation of salts in the marsh sediments are not considered. Also, the brackish reed, *Phragmites australis* can survive tidal inundation with saline water (35 ppt) if the roots and rhizomes are located in freshwater (Adams and Bate 1994c). PEDSSys does not consider the availability of aquifer water to estuarine plants.

Although PEDSSys can be used to predict an increase in plant growth, dynamic factors such as rate of expansion are not predicted. Quantitative trends such as the observed increase in *Zostera capensis* areal cover by a factor of 1.6 over the last 10 years (Adams and Talbot 1992), therefore, cannot be predicted.

The responses of phytoplankton and benthic microalgae to the different freshwater input scenarios could not be predicted as water column nitrate concentrations were not available. A general rule of the expert system is that if the water column is in a stable stratified condition and the water column nitrate is approximately $200 \mu\text{g l}^{-1}$ then phytoplankton biomass would be high (approx. $20 \mu\text{g chlorophyll-}a \text{ l}^{-1}$). Before the construction of the second dam in the catchment, floods were important in introducing nutrients to the estuary. Nitrate concentrations of $200 \mu\text{g l}^{-1}$ were associated with flood events in both July 1979 and July 1981 (Hanekom 1982). These pulses of nutrient rich freshwater may have been important in maintaining high phytoplankton biomass.

Today the lack of freshwater input possibly accounts for the low phytoplankton biomass ($< 5 \mu\text{g chlorophyll-}a \text{ l}^{-1}$). However, persistent high phytoplankton biomass is only maintained in an estuary such as the Sundays, if water residence times are long and stable stratified conditions are maintained. The results from the Estuarine Systems Model for the different scenarios show that an axial salinity difference greater than 10 ppt would be maintained at times in the Kromme Estuary for scenarios 1, 2, 4, 6 and 7. However under all scenarios apart from the natural run-off scenario, the Kromme appears to be a well mixed system with no significant change in tidal flushing for the different scenarios (Section 4.4.1). Under these conditions, low phytoplankton biomass can be expected. The Kromme would be a marine dominated estuary and the salt tolerant submerged macrophyte *Zostera capensis* would flourish. For the natural run-off scenario, *Zostera* biomass would fluctuate in response to freshwater floods. Since the construction of the second dam in the catchment, stable sediment and salinity conditions have resulted in an increase in the biomass and areal cover of *Zostera*.

4.3.4 Faunal Prediction Module

The method of application of this predictive module involved convening a workshop at which the faunal experts were present, presenting them with information on how the physical environment of the estuary would respond to various freshwater inflows and then soliciting their predictions of the faunal responses to the different physical states of the estuary. Thus predictions of the hydrodynamics and salinities which would prevail in the Kromme Estuary under the various run-off scenarios are necessary precursors to the implementation of faunal prediction. The short term faunal response predictions presented in Table 9 are limited to the first five run-off scenarios for the Kromme Estuary and exclude the intermediate run-off scenarios with 20% and 40% MAR freshwater supply as well as the disturbance scenario evaluations. However, these predictions are considered sufficient to illustrate the principal of including existing, non-formalised expertise on the response of functional faunal categories to alterations in freshwater inflow to an estuary.

Table 9 The predicted impact of run-off scenarios 1 to 5 (on the left) on the fauna of the Kromme Estuary. The species group status scale ranges from 0 (maximum impact/poor status) to 10 (pristine/status good). The community status scale ranges from 0 (poor status) to 80 (pristine/status good).

	ZOO- PLANKTON	BENTHOS		ICHTHYOFAUNA		AVIFAUNA		COMMUNITY
		migrant	resident	ichthyo- plankton	juvenile & adult	migrant	resident	
1	10	10	10	10	10	10	10	80
2	6	6	6	6	6	6	6	35
3	0	4	4	1	4	6	4	3
4a	3	5	5	4	5	6	5	20
4b	3	5	5	2	5	6	5	5
4c	4	5	5	3	5	6	5	10
4d	5	5	5	3	5	6	5	15
5	0	4	4	0	4-2	6	4	0

These faunal predictions utilize broad groupings and are a preliminary attempt to tackle a vast area of expertise in which formal decision support techniques could be useful. An indication of the usefulness of such an approach is the development of a fish recruitment index, the idea of which was initiated at the faunal prediction workshop, and its inclusion in the Estuarine Ecosystem Evaluation Model over the last two years of the predictive capability sub-project (Section 3.1.4).

4.3.5 Summary

The Mike 11 hydrodynamic and transport-dispersion modules and the Plant Estuarine Decision Support System (PEDSSys) were successfully applied to the problem of predicting the response of the Kromme Estuary to different freshwater inflow scenarios over a period of up to one year. Run-off scenarios ranging from the natural situation, through annual release volumes 40% of the natural MAR, to the situation of no freshwater inflow were selected for study and model simulations were conducted. The physical data from Mike 11 showed that for the natural run-off scenario and intermediate run-off scenario (40 % MAR) permanent freshwater/brackish

conditions would be a feature of the upper reaches. Additionally, the study revealed that the most important physical characteristics for the flora of the Kromme estuary are the fluctuating salinity and longitudinal salinity gradient rather than the current velocities and water levels. PEDSSys therefore predicted a negative growth rate adjustment score for the seagrass, *Zostera capensis* and a positive score for common reed, *Phragmites australis*, under the natural run-off scenario and intermediate run-off scenario (40 % MAR). For the no freshwater release scenario the growth rate adjustment score for *Zostera* was 10. This proved to be a realistic prediction as the no freshwater release scenario approximates conditions in the estuary today. There are two dams in the catchment with a combined capacity equivalent to one MAR resulting in little freshwater input to the estuary. *Zostera capensis* occurs from the mouth to the upper reaches because of the favourable salinity conditions (35 ppt), low turbidity and low current velocity associated with the lack of freshwater input.

The hydrodynamic data generated by Mike 11 were also utilized in the implementation of the water quality module. However, estimated water quality parameter values were used owing to a lack of appropriate data and the outputs are considered uncalibrated for the Kromme Estuary. Finally, a structured approach to short term faunal prediction was developed and implemented on the Kromme Case Study. This approach, based on capturing expert opinions through a formal workshop procedure, is rudimentary at present, but has already led to the incorporation of a fish recruitment index in the Estuarine Ecosystem Evaluation Model and holds promise for the development of an expert system for faunal prediction in the future.

4.4 Implementing Long Term Prediction on the Kromme Case Study

4.4.1 The Estuarine Systems Model

Calibration of the hydrodynamic aspects of the Estuarine Systems Model was achieved when agreement was obtained between the simulated water levels and tidal fluxes and those measured during an August 1988 field excursion. Calibration of the salt sector was achieved by comparison between the values measured on eight occasions by staff and students of the University of Port Elizabeth from April 1993 to March 1994. The flushing sector and the stratification-circulation sector were calibrated using a combination of these sets of observations, while the sediment sector relied heavily upon bathymetric surveys of the mouth area and a study by the CSIR (1991) for calibration data. Comparisons with Mike 11 predictions were also undertaken as checks on the accuracy of the ESM predictions.

All model simulations were conducted for a two year period, commencing on 1 October for each of the run-off scenarios. Only the results of the second year of the simulation are presented so that any influence that the choice of initial conditions might have imposed on the model results would have dissipated. The initial conditions include the assumption that the estuary has a mean salinity of 32 ppt on 1 October, that the sill height at the mouth is 0.09 m to MSL and that the system is well mixed.

Model Results

There were no significant changes in tidal flux, water levels, current speeds and the height of the sill at the mouth with the different run-off scenarios. This is an artefact of the exclusion of severe flooding and consequent sediment scour from this study and the assumptions made in the formulation of the run-off scenarios regarding the maximum inflow rate. This was assumed to be between 20 and 22 m³/s and perforce excluded hydrodynamic and sediment dynamic effects. Thus the effects of the different inflow scenarios are observed primarily in the different salinity regimes which occur and the discussion of model results will concentrate on these. The water levels in the Kromme Estuary typically vary between 0,2 m + MSL and 1, 0 m + MSL, while the maximum flood tidal flux is of the order of 150 m³/s under all of the run-off scenarios.

1. The natural run-off scenario

The inflow to the estuary under the natural run-off scenario was simulated by imposing the seasonality of the Eastern Cape region on the average annual run-off. This means that no large floods were simulated, nor low flow periods. Rather, the long term average situation was simulated assuming the rainfall and evaporation figures representative of the region. The mean salinity in the estuary (Figure 4.14a) consequently is strongly seasonal with low mean salinities of less than 10 ppt in the high flow season (September to mid December) and high mean salinities of greater than 28 ppt in the dry season (mid February to mid April). Only in the dry season does the head to mouth salinity difference decrease below 20 ppt (Figure 4.14b). The stratification index exceeds 0,08 for most of the September and October period, indicating that even under the strong freshwater flows of the natural situation, the Kromme Estuary probably was in a well mixed state for most of the year. Superimposed on the seasonality of the mean salinity is a higher frequency spring-neap tidal influence, which as expected can also be detected in the stratification index.

2. The intermediate run-off scenario (10% of the natural MAR)

The 1 in 2 year flood, which enters the estuary on 15 November, causes almost all of the salinity to be expelled from the system in that the mean salinity drops to about 6,5 ppt. A condition of mean salinity less than 10 ppt is maintained for about 15 days, but the effect of the flood on mean salinities has dissipated substantially by mid December and entirely by the end of December

(Figure 4.15a). The axial salinity differences bear these effects out, exhibiting values of 35 ppt at the height of the flood and for a month thereafter, but declining to less than 2 ppt by the end of December (Figure 4.15b). The effect of the freshette on 15 March is shortlived with mean salinities returning to their usual values of between 32 and 34 ppt (subject to spring neap tidal influence) within a month and axial salinity differences also decreasing from a maximum of 18 ppt to less than 2 ppt within a month. The stratification index rises above 0,08 briefly under the influence of the 1 in 2 year flood, indicating that a degree of stratification may be present under flood conditions.

3. *The present run-off scenario*

The mean salinity of the estuary is barely affected by the monthly freshwater releases currently undertaken, exhibiting slight decreases in value at the time of the releases but remaining consistently above 31 ppt, varying with the spring neap tidal cycle (Figure 4.16a). The head to mouth salinity differences are also consistently less than 2,5 ppt (Figure 4.16b), indicating that the estuary is virtually a sheltered extension of the sea under the present run-off scenario. Stratification is absent.

4. *Alternative run-off scenarios totalling an annual volume of $2 \times 10^6 \text{ m}^3$ per annum*

(a) *One large release per year (in early summer)*

Under this release policy, the mean salinities decline from values between 32 and 34 ppt to 22,5 ppt in mid November (Figure 4.17a). Lower mean salinities are exhibited for slightly less than a month and the dominant effect on salinities for the rest of the year is exerted by the spring neap tidal cycle. However, a head to mouth axial salinity gradient of 35 ppt is achieved for about a week, but dissipates fairly rapidly and all effect on the axial salinities has disappeared within a month (Figure 4.17b). Stratification is minimal.

(b) *Two releases of equal volume per year (early summer and six months later)*

The effect of the freshwater releases on the mean salinity in the estuary varies slightly according to the stage of the spring neap tidal cycle at the time of the release. On the 15 November, the mean salinity of the estuary was higher than on 15 May. The minimum mean salinity achieved was thus lower under the second release than under the first, but both are in the region of 27 ppt (Figure 4.18a). The effects of the releases on mean salinities dissipated completely within a month in both cases. The axial salinity differences achieved were between 18 ppt and 20 ppt, although the effect was temporary and these declined fairly rapidly (Figure 4.18b).

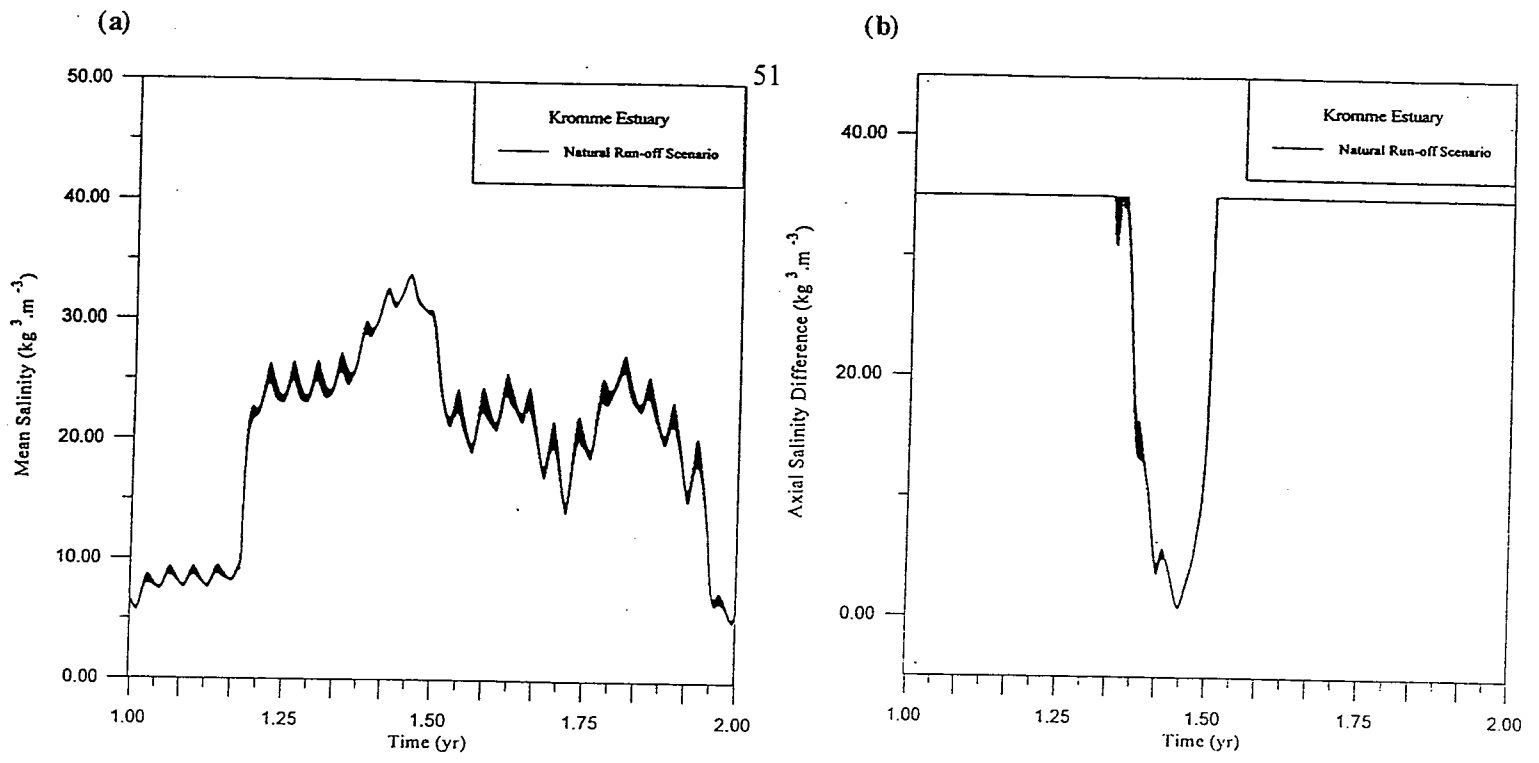

Figure 4.14 The mean salinities (a) and axial salinity differences (b) in the Kromme Estuary under the natural run-off scenario.

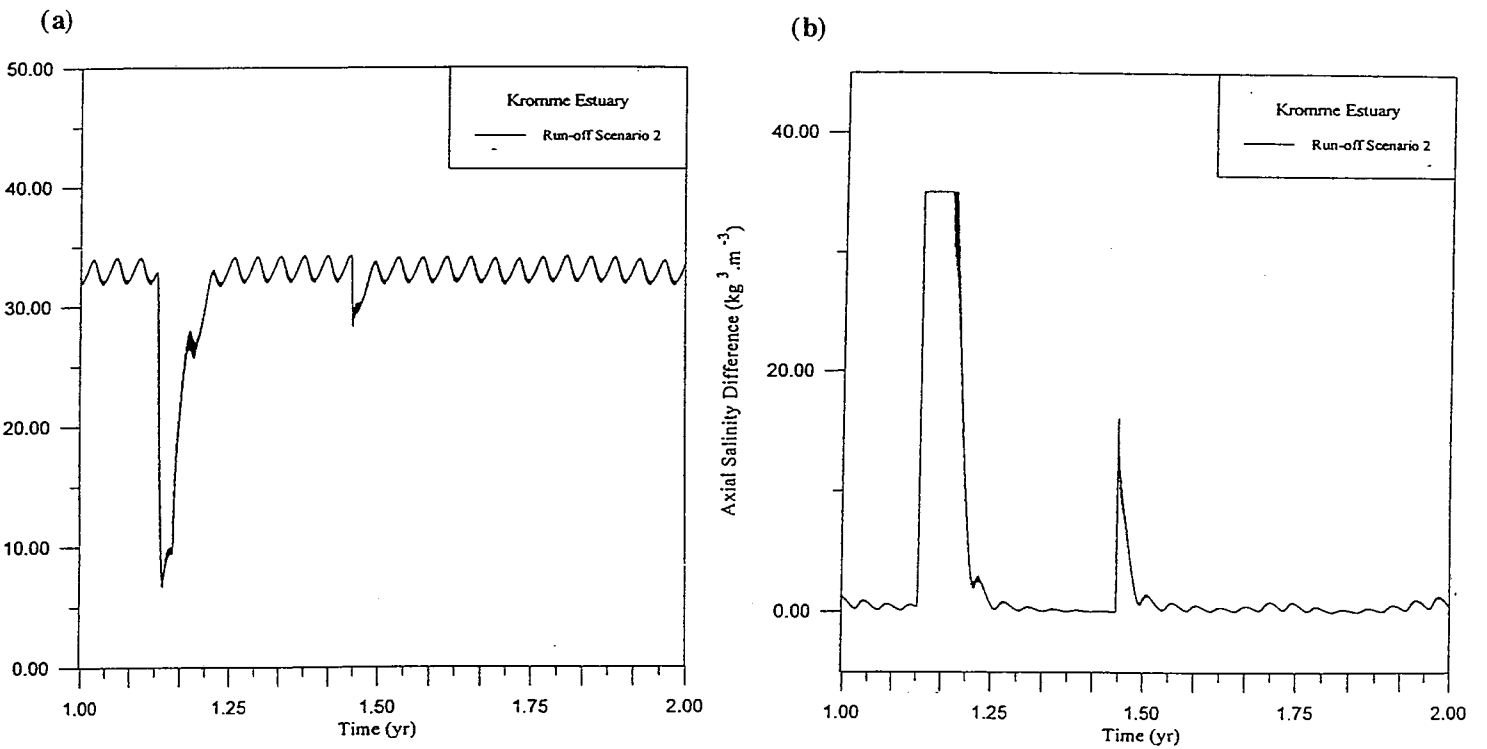

Figure 4.15 The mean salinities (a) and axial salinity differences (b) in the Kromme Estuary under the intermediate run-off scenario 2.

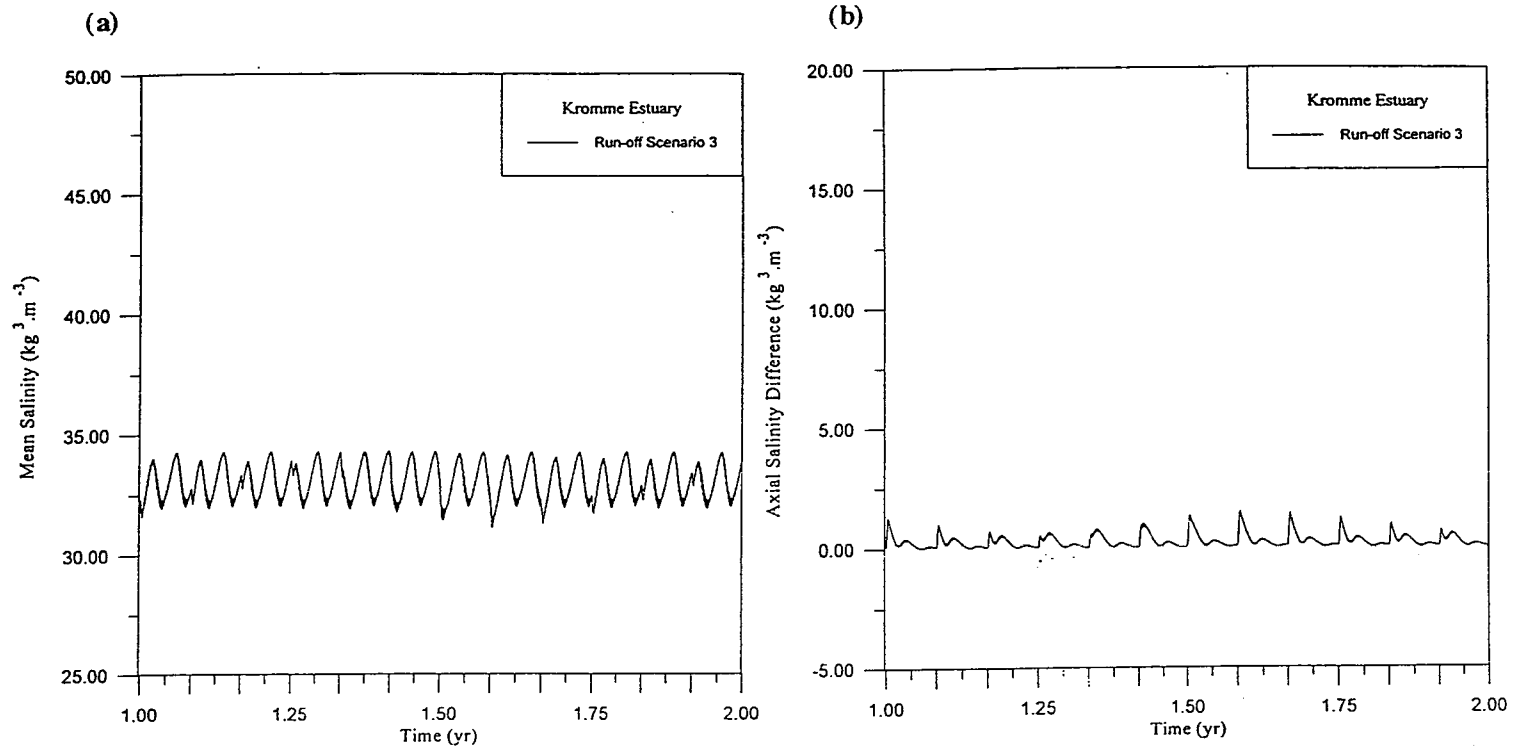

Figure 4.16 The mean salinities (a) and axial salinity differences (b) in the Kromme Estuary under the present run-off scenario.

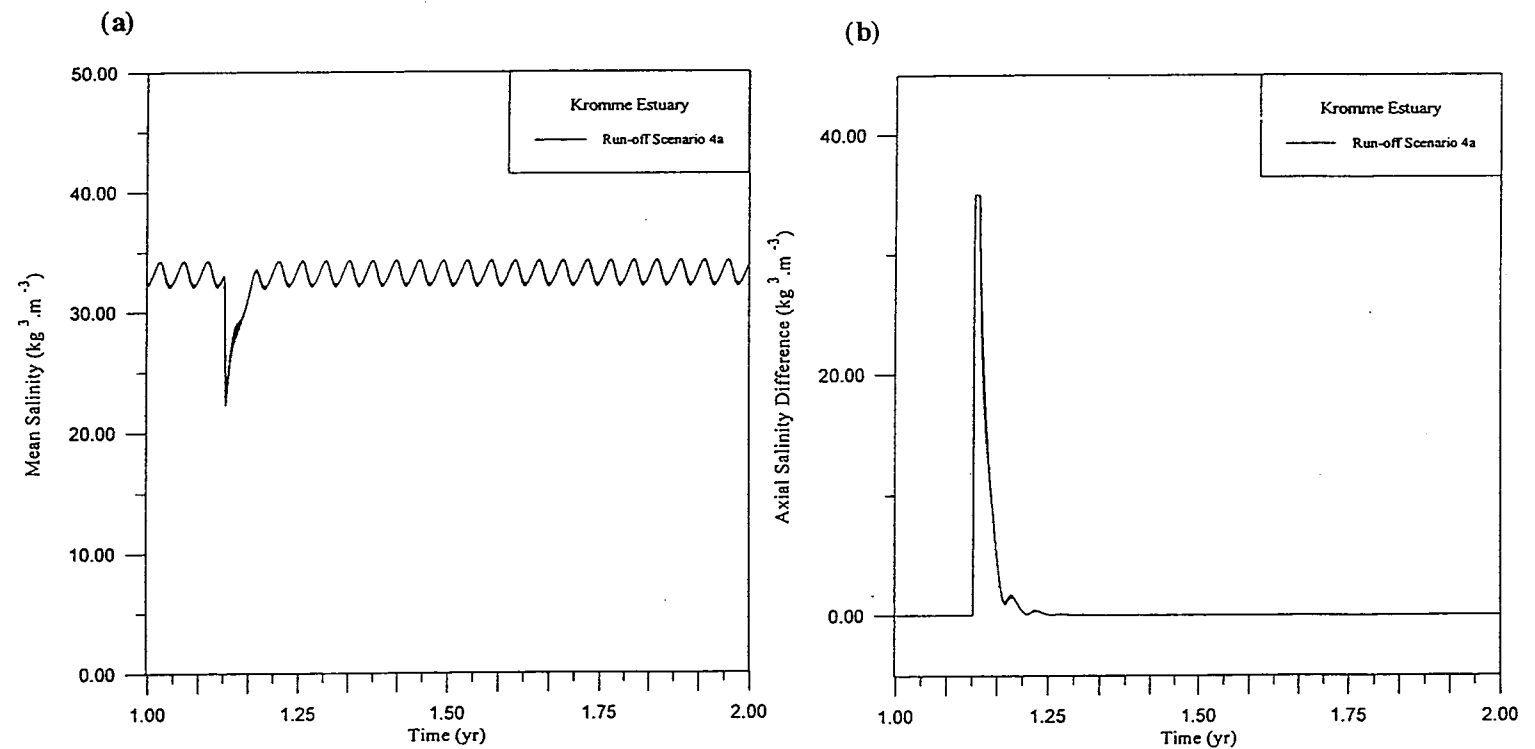

Figure 4.17 The mean salinities (a) and axial salinity differences (b) in the Kromme Estuary under run-off scenario 4a.

(c) *Two releases of equal volume per year (early summer and four months later)*

Both releases cause the mean salinities to decrease to about 27 ppt, yet their effect dissipates within the month (Figure 4.19a). The axial salinity differences (Figure 4.19b) resulting from the releases lie between 17 and 18 ppt, but these effects are temporary.

(d) *Three releases per year (larger release in early summer, 2 smaller releases later, but not in winter)*

The effect of the first release is the same as described in the previous two scenarios. The effects of the two smaller releases on mean salinities are very slight and mean salinities do not decline below 30 ppt as a result of the releases (Figure 4.20a). This is borne out by the axial salinity difference values which remain below 5 ppt at the time of the two smaller releases (Figure 4.20b).

5. *No freshwater releases*

Mean salinities are consistently higher than 32,4 ppt throughout this simulation and vary strongly with the spring neap tidal cycle, but do not exceed 35 ppt (Figure 4.21). Although, the Estuarine Systems Model does not accommodate the prediction of hypersalinities at present, it is clear that the propensity for hypersaline conditions to occur is high.

6. *The intermediate run-off scenario (20% of the natural MAR)*

While this scenario and scenario 2 are similar in the 1 in 2 year freshwater flood they receive, they differ in that Scenario 6 receives about $11 \times 10^6 \text{ m}^3$ per annum more in base flow and a freshette double the volume of Scenario 2. The mean salinities present in the estuary therefore are slightly lower under this run-off scenario than under scenario 2 and also exhibit some seasonality. The effect of the 1 in 2 year flood is enhanced in that the return to the mean salinity values prior to the onset of the event is delayed by a few days compared with scenario 2 and the head to mouth salinity differences remain at 35 ppt for more than a month (Figure 4.22). The late summer flood also achieves an axial salinity difference of 35 ppt in the estuary and this is maintained for about a week. Although the base flow contributes significantly to sustaining a longitudinal salinity gradient greater than 10 ppt during the months of September and October, it still appears insufficient to maintain a brackish component in the estuary.

7. *The intermediate run-off scenario (40% of the natural MAR)*

The difference between the freshwater inflow to the estuary under this scenario and under the previous scenario lies in the base flow which totals about $37 \times 10^6 \text{ m}^3$ per annum in this case. The influence of this strong base flow is clear in the seasonality exhibited in the mean salinities. Mean salinities exceed 30 ppt for less than 8 months of the year under this scenario and the effects on the mean salinity of the enhanced base flow in June and September / October are equivalent to the effects of the flood of 15 March (Figure 4.23a). The 1 in 2 year flood remains

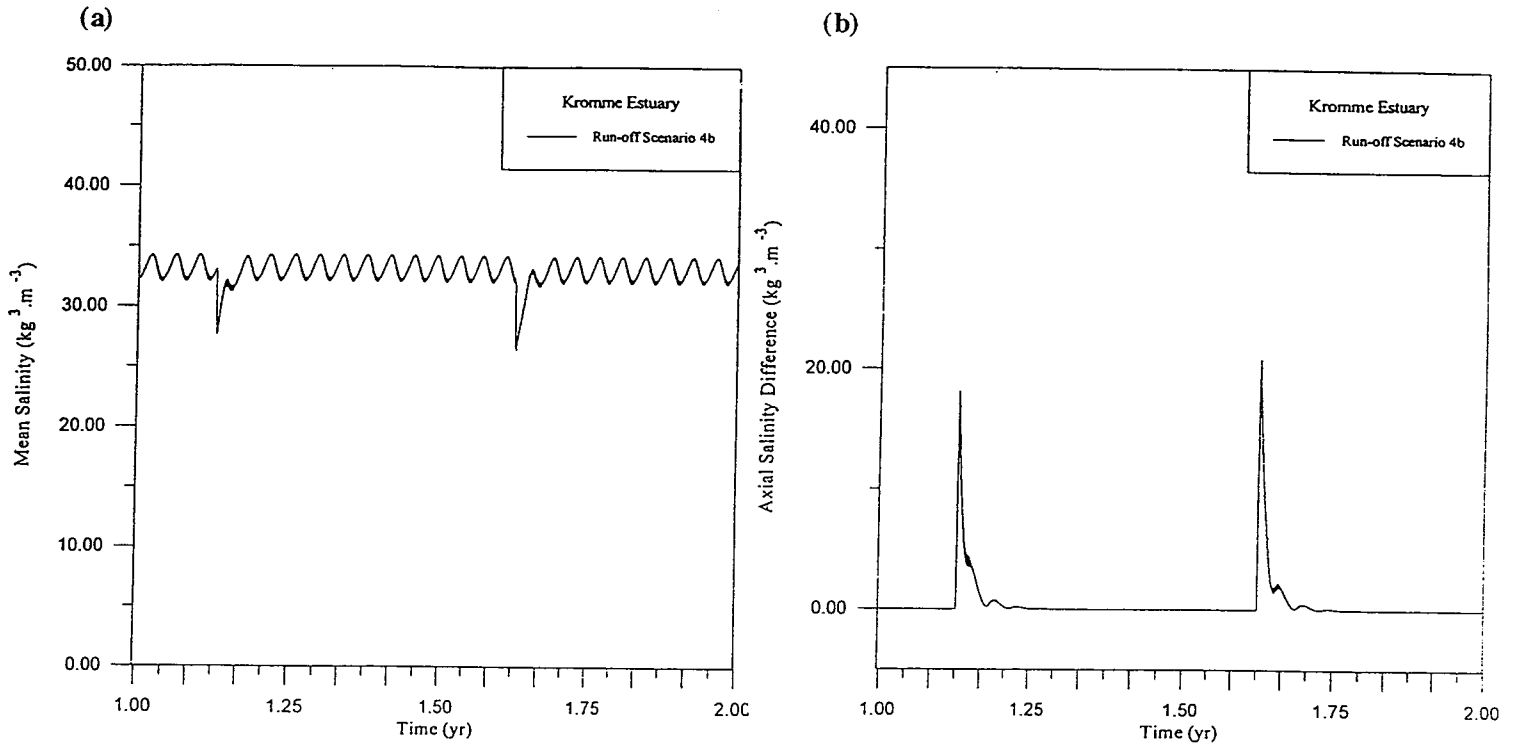

Figure 4.18 The mean salinities (a) and axial salinity differences (b) in the Kromme Estuary under run-off scenario 4b.

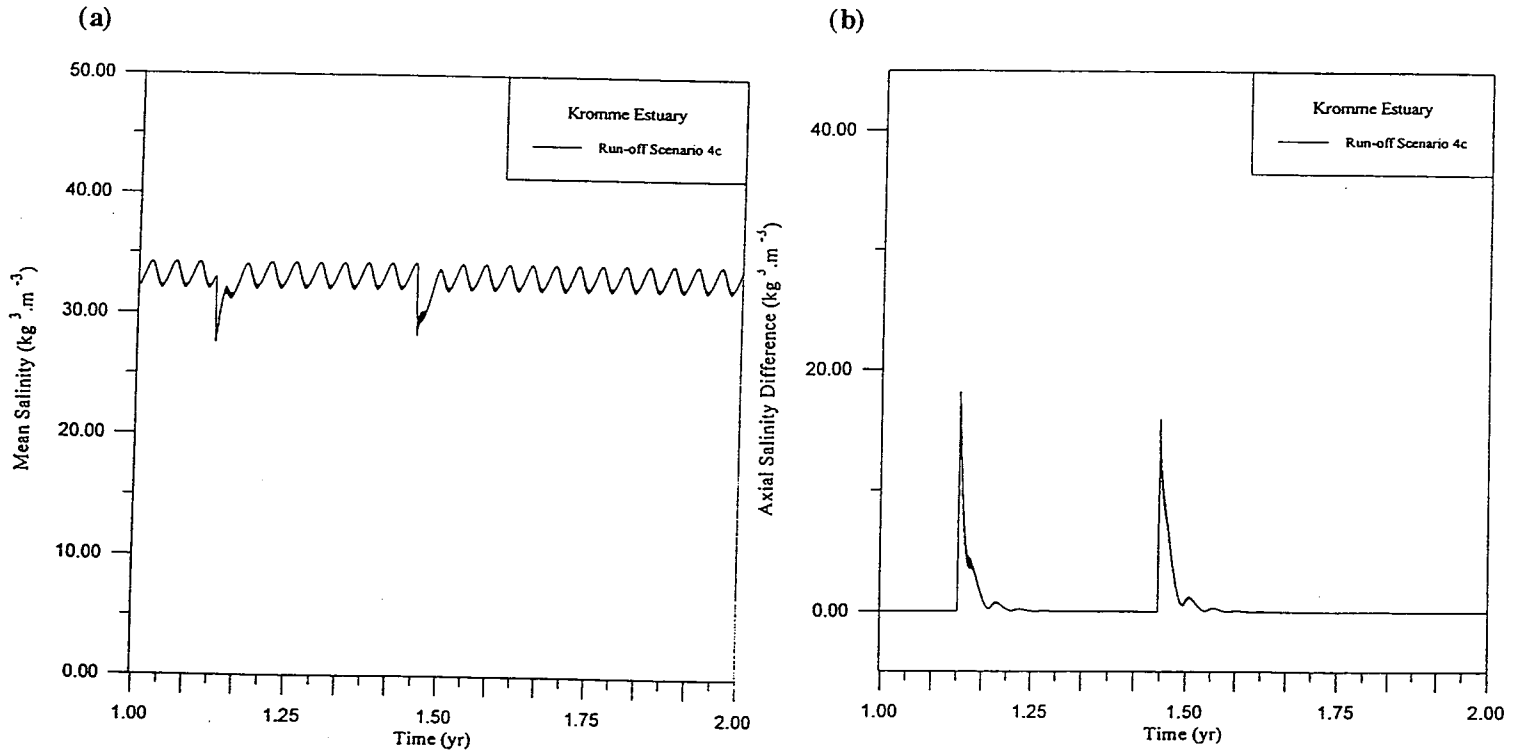

Figure 4.19 The mean salinities (a) and axial salinity differences (b) in the Kromme Estuary under run-off scenario 4c.

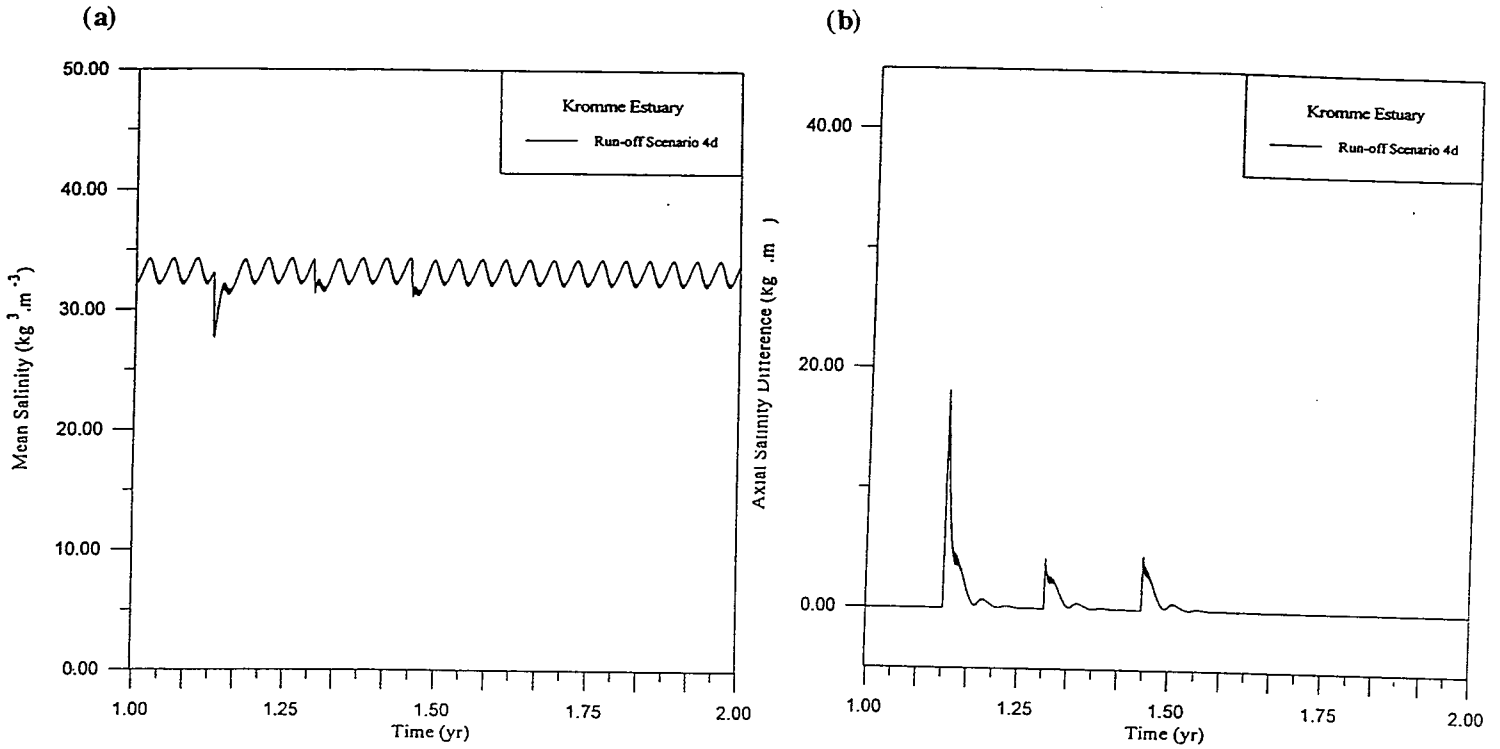

Figure 4.20 The mean salinities (a) and axial salinity differences (b) in the Kromme Estuary under run-off scenario 4d.

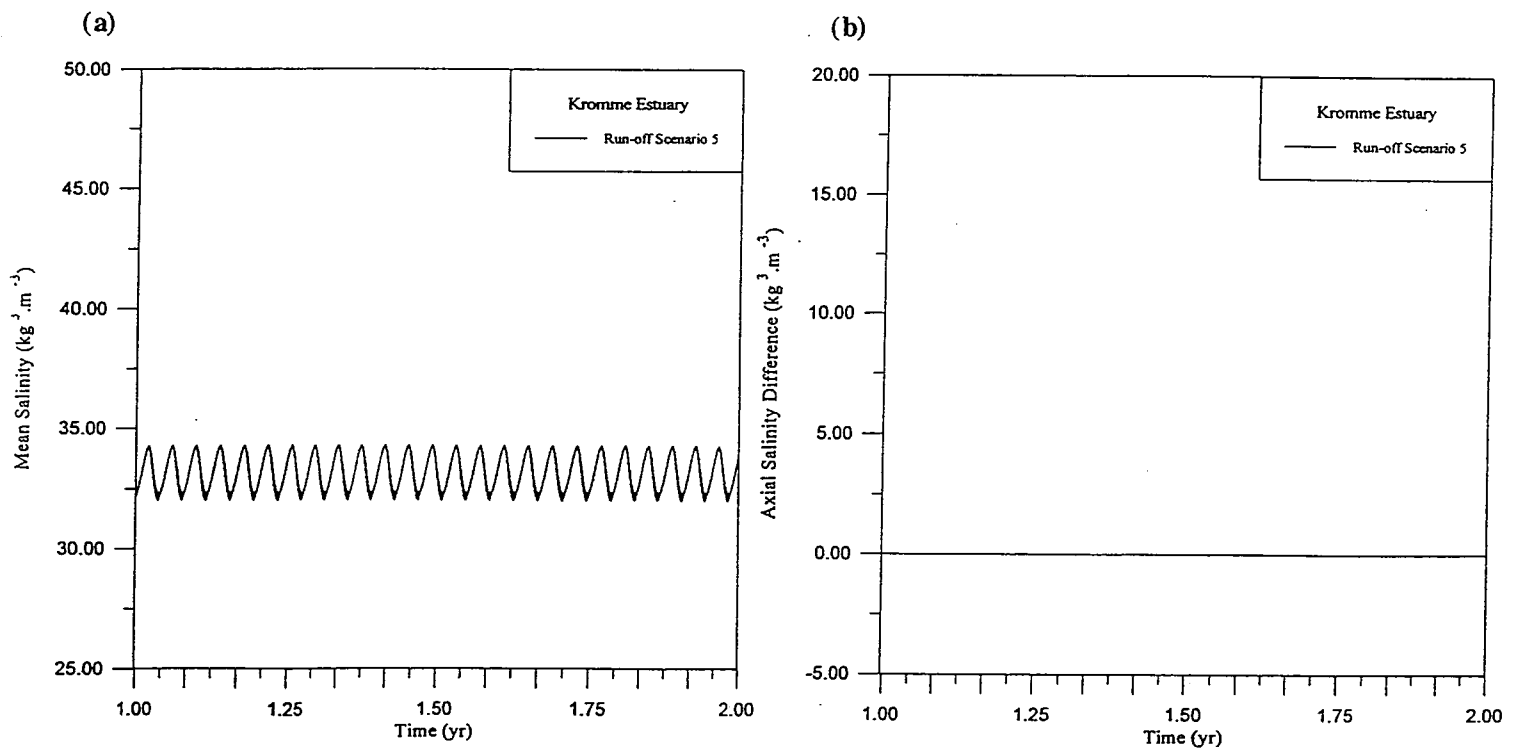

Figure 4.21 The mean salinities (a) and axial salinity differences (b) in the Kromme Estuary under run-off scenario 5.

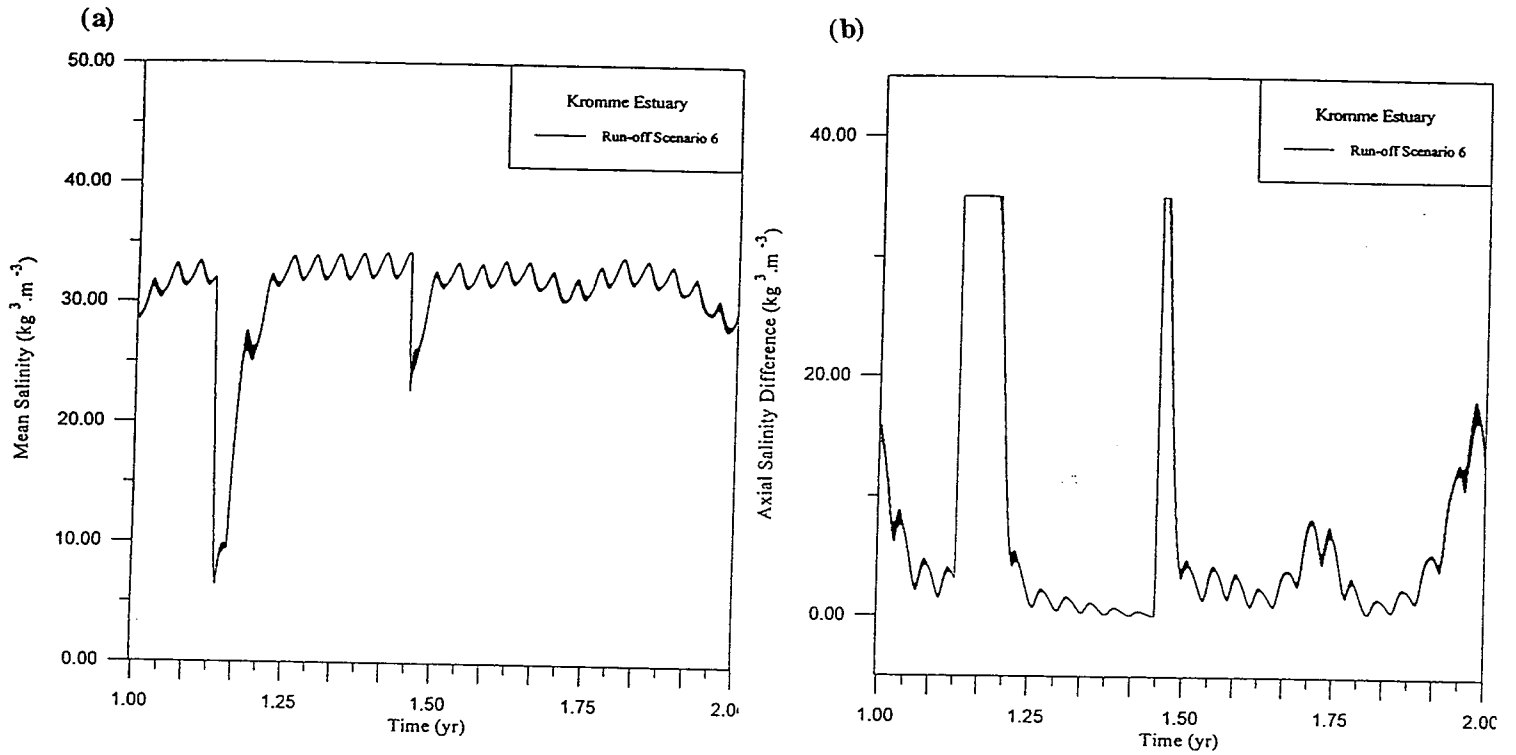

Figure 4.22 The mean salinities (a) and axial salinity differences (b) in the Kromme Estuary under run-off scenario 6.

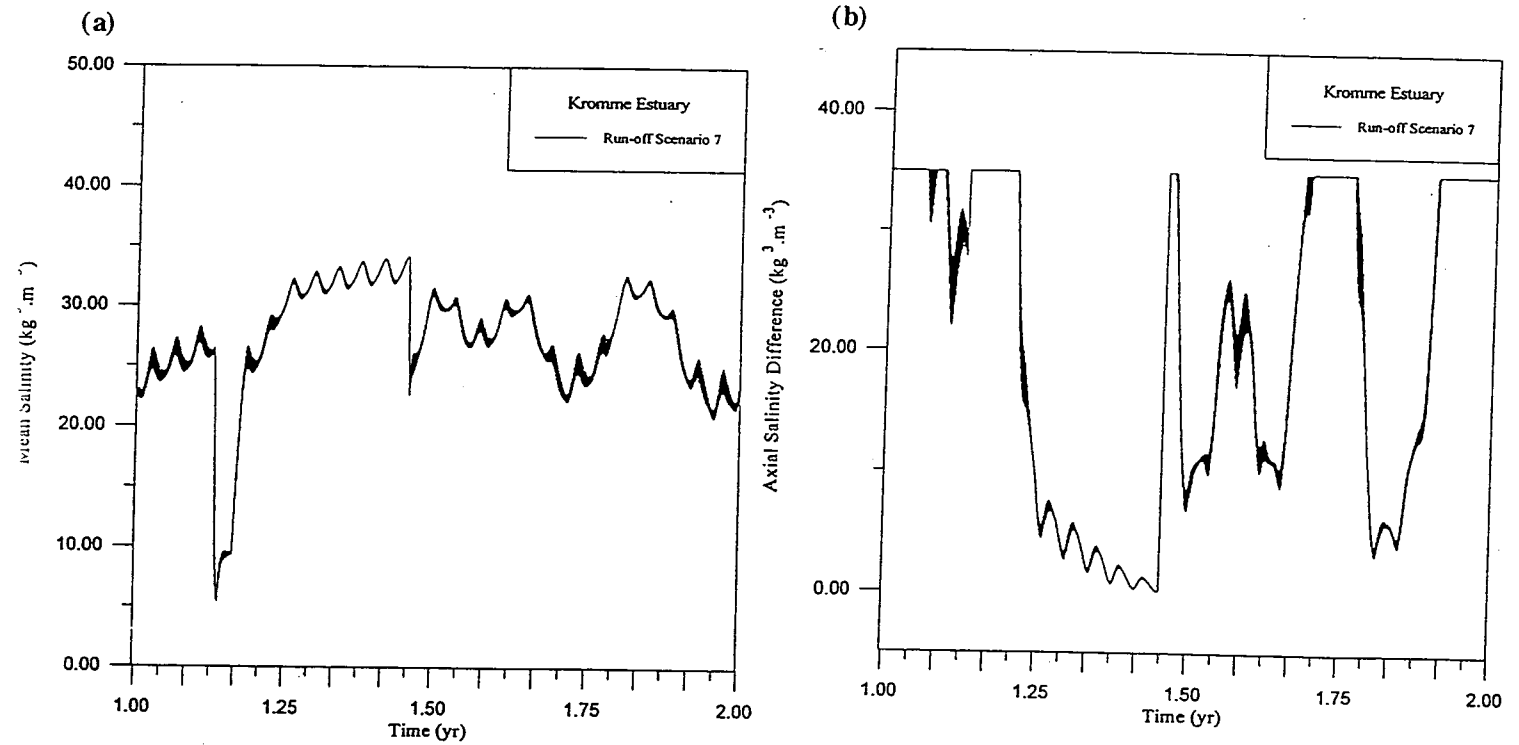

Figure 4.23 The mean salinities (a) and axial salinity differences (b) in the Kromme Estuary under run-off scenario 7.

important in that a sustained longitudinal gradient of 35 ppt is maintained for more than a month over the late summer period. It is noteworthy, however, that axial salinity differences of 35 ppt are predicted for about 5 months of the year (Figure 4.23b), indicating that a brackish component probably is maintained in the estuary under this release scenario.

8. *Disturbance Scenario: No freshwater flow to the estuary for three years*

As the Estuarine Systems Model does not accommodate the prediction of hypersalinities, it is not very helpful to apply it to this scenario. However, the application was undertaken for completeness sake and the results indicate the minimum mean salinities would consistently exceed 32,4 ppt.

Model Limitations and Range of Application

A limitation of the Estuarine Systems Model which is clear from this study, is its inability to predict hypersalinities. One can infer their likelihood of occurrence from high mean salinity values, but the concentrations achieved cannot be predicted. Fortunately, Mike 11 handles this aspect well. Another factor to emerge from this study, on the positive side, is the utility of the function providing the axial salinity differences. The inability to predict longitudinal salinity differences was identified as a weakness of the model in the first year of the predictive capability sub-project and successful model development was undertaken on this aspect in the last two years of the project. Clearly, the ESM is now applicable to a permanently open, freshwater starved system such as the Kromme Estuary.

Daily inflows, minimum and maximum water levels, average mean salinities, stratification index values, flushing rates, sill heights at the mouth, maximum current velocities through the mouth and tidal fluxes were supplied by ESM to the other long term models (DVM and EEEM) as well as to PEDSSys for phytoplankton bloom prediction.

4.4.2 The Dynamic Vegetation Model

Zostera capensis and *Phragmites australis* were selected for consideration in the application of the dynamic, one-dimensional, spatial, biomass growth model for estuarine macrophytes to the Kromme Case Study. *Zostera capensis* is a submerged macrophyte that is rooted in lower intertidal and subtidal substrata, which is common in permanently open, marine dominated estuaries. *Phragmites australis* is a rhizomatous grass species dominating the brackish upper reaches of South African estuaries. In contrast to the Great Brak Case Study, *Ruppia cirrhosa*

was omitted from consideration because it cannot survive regular exposure or strong currents and so only occurs in temporarily open estuaries.

Details of the model equations and parameters are contained in the appendix.

Model Results

The values assigned to the parameters were: the specific growth rates, $sgr(Zostera) = 0.005 \text{ g.g}^{-1} \cdot \text{day}^{-1}$, $sgr(Phragmites) = 0.05 \text{ g.g}^{-1} \cdot \text{day}^{-1}$, expansion = $0.5 \text{ g.g}^{-1} \cdot \text{day}^{-1}$, $k = 100 \text{ kg.m}^{-2}$, scour = $3 \text{ g.g}^{-1} \cdot \text{day}^{-1}$, exposure = $3 \text{ g.g}^{-1} \cdot \text{day}^{-1}$. The constant scour (exposure) was taken to be high so that when velocity (exposure time) is high, the death term due to scour (exposure time) is large and the whole biomass is lost.

Model simulations for run off scenarios 1 to 5

To provide a reference framework the model was run at a particular station until the system reached equilibrium (i.e. it was run until the system oscillated in a yearly repetitive cycle of macrophyte biomass). Initial populations were assumed to be half the carrying capacity of the environment.

Production was determined from the growth rate and reproductive success. This was simulated and compared with the productivity of a reference scenario (taken as the present run-off scenario), to give some idea of whether productivity increased or decreased under the different run-off scenarios.

The results are presented in Tables 10 and 11. Table 10 shows the *Zostera* productivity for each scenario relative to scenario 3. For each scenario, values are given for sites 1 to 5, located at distances of about 0, 3.1, 6.1, 10.1 and 13 km upstream of the mouth. A value for a site is calculated by averaging the productivity values at all the positions along the river bank. Table 11 shows the average equilibrium biomass of *Zostera* for each scenario for sites 1 to 5 relative to scenario 3. At a site the average biomass is calculated by averaging all the equilibrium biomass values along the river bank. In Table 12, the average equilibrium biomass of *Zostera* and *Phragmites* under scenarios 1 and 3 are presented.

No significant differences occur in the average equilibrium biomass or the average productivity of *Zostera* under the run off scenarios 2, 4a, 4b, 4c, 4d and 5, indicating that these scenarios and that of scenario 3 are similar for *Zostera*. However, a marked decline in average productivity is associated with positions 4 and 5 in the upper reaches of the estuary under natural run-off conditions. A similar feature is evident in the average equilibrium biomass, which is lower at positions 3, 4 and 5 under the natural run-off situation than under any of the other scenarios.

Table 10 *Zostera* productivity under the run-off scenarios 1 to 5, relative to scenario 3, for 5 positions in the Kromme Estuary .

Run-off Scenario	Site 1	Site 2	Site 3	Site 4	Site 5
1	1.002	0.95	0.087	0.035	0.034
2	1.01	1.002	1.00	0.99	0.99
3	1.00	1.00	1.00	1.00	1.00
4a	1.006	1.006	1.004	0.99	1.009
4b	1.006	1.008	1.006	0.99	1.009
4c	1.00	1.002	1.002	0.99	1.004
4d	1.00	1.006	1.003	0.99	1.003
5	0.99	0.99	0.99	0.99	0.99

Table 11 The average equilibrium biomass of *Zostera* under the run-off scenarios 1 to 5, relative to scenario 3, for 5 positions in the Kromme Estuary

Run-off Scenario	Site 1	Site 2	Site 3	Site 4	Site 5
1	0.99	0.95	0.062	0.024	0.023
2	1.006	1.003	1.00	0.99	1.00
3	1.00	1.00	1.00	1.00	1.00
4a	1.006	1.007	1.004	0.99	1.01
4b	1.007	1.008	0.99	0.99	1.01
4c	1.00	1.002	1.002	0.99	1.004
4d	1.001	1.007	1.003	0.99	1.004
5	0.99	0.99	0.99	0.99	0.99

This indicates that *Zostera* would not have colonised all areas of the estuary under natural conditions, but would have been excluded from the upper, brackish reaches. *Phragmites* would have occupied these upper reaches under the natural run-off scenario owing to the persistence of a strong axial salinity gradient. Under the other run-off scenarios, unlike the natural run-off scenario, a strong longitudinal salinity gradient is not maintained throughout the year owing to reduced fresh water inflow, and *Zostera* begins to encroach up the estuary and displace *Phragmites*.

Table 12 The average equilibrium biomass of *Zostera* and *Phragmites* under the run-off scenarios 1 and 3, for 5 positions in the Kromme Estuary

Run-off Scenario	Plant	Site 1	Site 2	Site 3	Site 4	Site 5
1	<i>Zostera</i>	36	36	4	2	2
	<i>Phragmites</i>	5	77	77	78	78
3	<i>Zostera</i>	37	37	36	36	38
	<i>Phragmites</i>	0.2	0.2	0.3	0.3	0.3

The lateral distribution of biomass is similar under all of the run-off scenarios (Figure 4.24). Since water levels never rise to over 1,3 m and the turbidity is assumed to be low, there is enough light at the bottom of the water column for *Zostera* to survive. The average biomass therefore is greatest from the deepest section of the channel to about 0,5 m along the bank (continuously submerged). Between 0,5 m to about 0,7 m the average biomass decreases, owing to exposure during low tides. Further up the bank there is very little biomass because total exposure occurs frequently.

Model simulations for run off scenarios 6 to 8

These run-off scenarios were applied as disturbances to scenarios 1, 3 and 5. After a disturbance scenario was applied, the model was re-run using the original scenario data to give an indication of how resilient the systems are to change. The parameter used to measure resilience is the settling time, which is defined as the time taken for a system to return to within 90% of its equilibrium value after a disturbance. Results are given in Tables 13, 14 and 15.

Scenario 1 is the only scenario that is affected by the disturbance from scenario 6 and scenario 7, because there is an increase in salinities at each site under these release policies. This leads

to an increase in *Zostera* biomass at each site during the disturbance because *Zostera* grows best under salinities of 30 to 35 ppt. Near the mouth, (at sites 1 and 2), the settling time is zero because the effects of different fresh water releases are more noticeable upstream than at the mouth where high salinities are maintained by the tide.

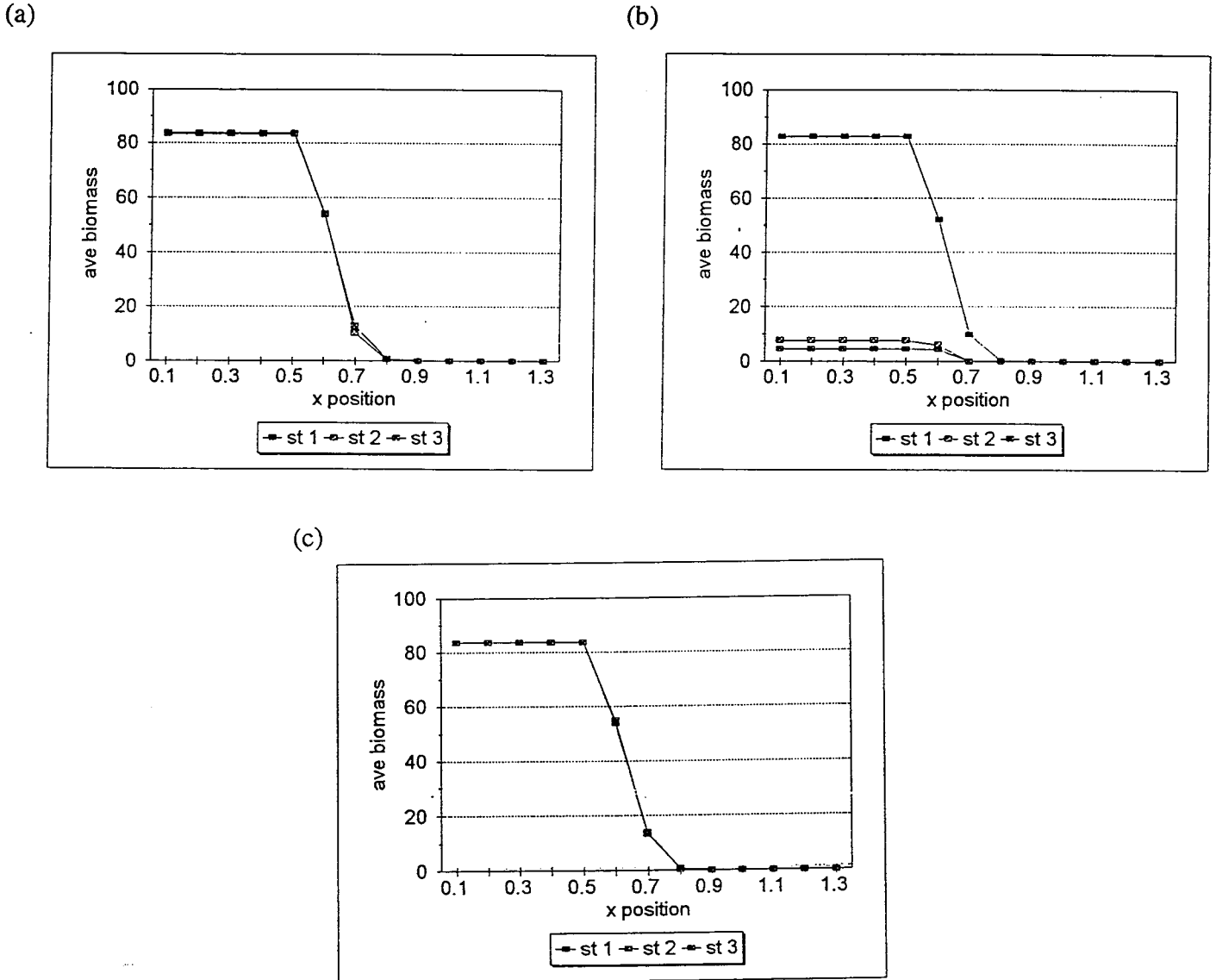

Figure 4.24 The lateral distribution of the equilibrium biomass of *Zostera* under the present run-off scenario (a), the natural run-off scenario (b) and scenario 4a (c).

The disturbance caused by scenario 8 affects all of the run-off scenarios 1, 3 and 5, and biomass values for all scenarios decrease to nearly zero under scenario 8. Where no recovery is indicated, it means that there is insufficient biomass for *Zostera* to start growing again after the disturbance.

Note that the model predicts that *Zostera* biomass will not achieve levels characteristic of those prior to the disturbance for a considerable period of time under most scenarios.

It is significant that the highest degree of perturbation of the *Zostera* biomass occurs when disturbance scenarios are applied to the natural run-off scenario. This is indicative that under natural conditions a high degree of variability exists in the state of the ecosystem, an indication of ecosystem health. Severely impacted systems are known to exhibit reduced variability and uniform conditions for large parts of a year.

Table 13 The settling time in years of *Zostera* under the run-off scenarios 1, 3 and 5 after a disturbance from scenario 6.

Run-off Scenario	Site 1	Site 2	Site 3	Site 4	Site 5
1	0	0	4	4	3
3	0	0	0	1	1
5	0	0	0	1	1

Table 14 The settling time in years of *Zostera* under the run-off scenarios 1, 3 and 5 after a disturbance from scenario 7.

Run-off Scenario	Site 1	Site 2	Site 3	Site 4	Site 5
1	0	0	3	2	1
3	0	0	0	1	1
5	0	0	0	1	1

Table 15 The settling time in years of *Zostera* under the run-off scenarios 1, 3 and 5 after a disturbance from scenario 8.

Run-off Scenario	Site 1	Site 2	Site 3	Site 4	Site 5
1	3	3	no recovery	no recovery	no recovery
3	2	2	2	2	2
5	2	2	2	2	2

Model Limitations and Range of Applicability

The dynamic model for estuarine vegetation described above is useful for representing and analysing the response of *Zostera* and *Phragmites* (located in different regions in the estuary) to changes in salinity, water level and flow velocity. For instance, this model can indicate quantitatively the lateral biomass gradient and the degree to which growth is reduced along the river bank by a specific run-off scenario. Indications of changes in the longitudinal biomass of *Zostera* and of *Phragmites* are obtained by solving the model for different sites along the length of the estuary.

The inclusion of species such as *Phragmites* and *Zostera* enhances the dynamic prediction of the response of estuarine flora to different run-off scenarios, because *Phragmites* favours brackish conditions whereas *Zostera* favours saline conditions.

4.4.3 The Estuarine Ecosystem Evaluation Model

This model comprises two indices; the first was developed to provide an estimate of biomass production by a key estuarine invertebrate, the mud prawn, and the second to provide an indication of the likely success of fish recruitment into an estuary, given a range of freshwater inflow scenarios. The index of invertebrate production is a measure of the extent to which *Upogebia africana* achieves the level of production it would in an estuary under ideal conditions. Since the model simulates the process of recruitment and growth of cohorts of *Upogebia africana*, it was necessary to run each run-off scenario repeatedly for several years. The invertebrate production index is thus based on the proportion of biomass present relative to that which would be present after 7 years of ideal conditions. As the fish recruitment is focused on a process which occurs over an annual cycle it was only necessary to simulate the success of recruitment over a two year period.

Model Results

1. The natural run-off scenario

The axial salinity gradient predicted by the Estuarine Systems Model decreases below 35 ppt for less than two months of the year, during the low flow period in March. Consequently fish recruitment occurs at full potential, only decreasing to 10% of potential during March (Figure 4.25). The mean score of the index is 87. Under the natural run-off scenario, production of *Upogebia africana* is good, reaching 91% of the production which could be expected under ideal conditions (Figure 4.25).

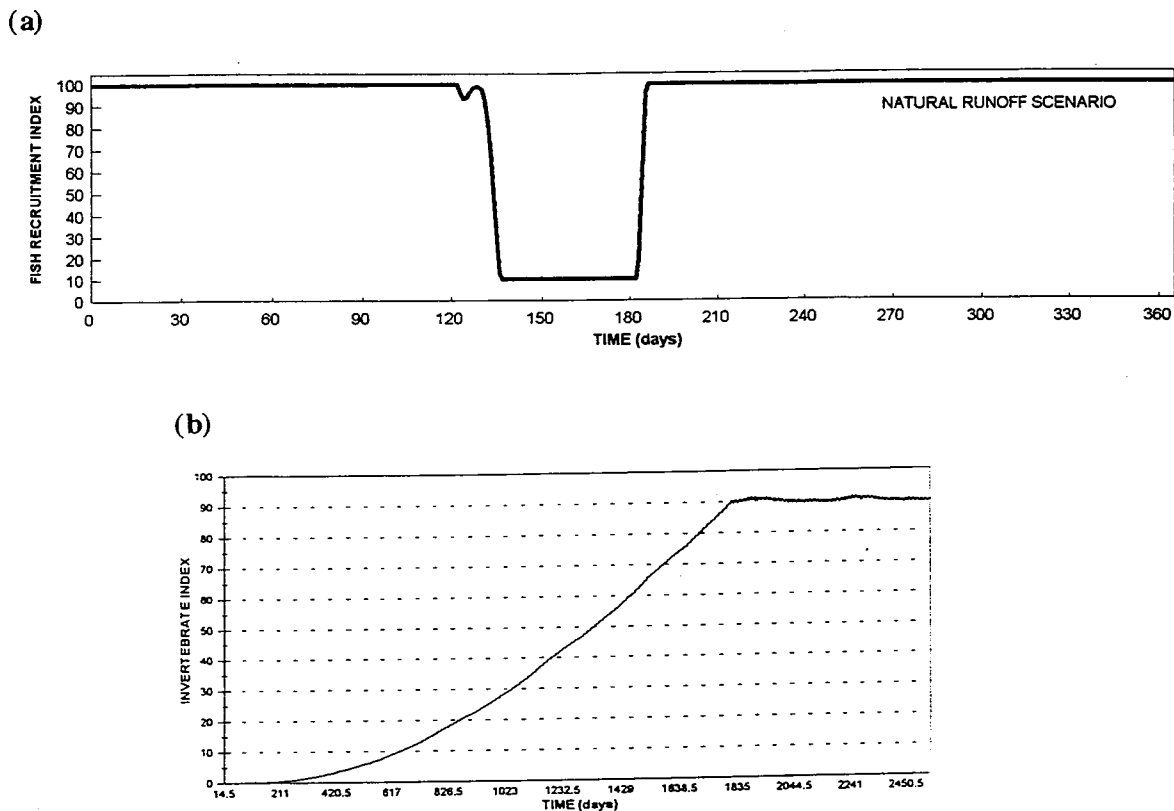

Figure 4.25 The fish recruitment index (a) and the invertebrate production index (b) under the natural run-off scenario

2. The intermediate run-off scenario (10% of the natural MAR)

The axial salinity gradient only exceeds 20 ppt for approximately one month during the early summer flood, permitting fish recruitment to occur to the maximum for the period mid November to mid December (Figure 4.26). The flood is well timed as it occurs at the time of year when the maximum number of species are recruiting. The second flood does not induce an axial salinity difference of greater than 20 ppt and consequently has no influence on fish recruitment. The mean index score for the year is 15. In the case of this scenario, *Upogebia africana* achieves 76% of the potential maximum production (Figure 4.26).

3. The present run-off scenario

Under present run-off conditions, the axial salinity gradient does not exceed 5 ppt and as a consequence recruitment occurs only at a fraction of potential (Figure 4.27). However since the average salinity does not vary markedly from the previous scenario, the biomass of *Upogebia africana* reached 77% of the potential maximum production (Figure 4.27).

(a)

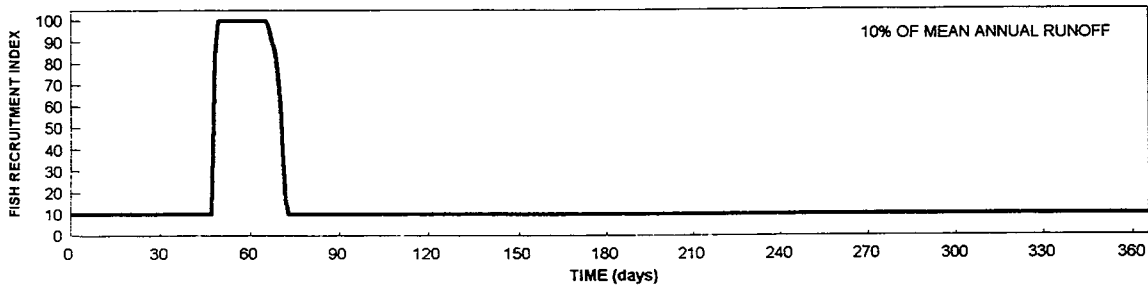

(b)

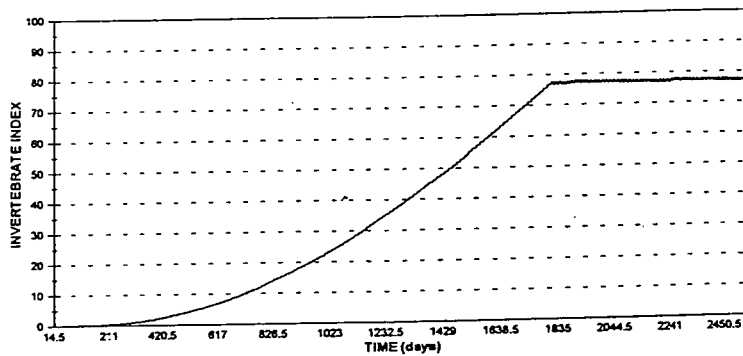

Figure 4.26 The fish recruitment index (a) and the invertebrate production index (b) under the intermediate run-off scenario 2

4. *Alternative run-off scenarios totalling an annual volume of $2 \times 10^6 \text{ m}^3$ per annum*

Fish recruitment predictions were not undertaken for these scenarios. Neither the single flood event (Figure 4.28) nor two releases (Figure 4.29), nor three releases caused any significant impact upon *Upogebia africana*.

5. *No freshwater releases*

Fish recruitment predictions were not undertaken for this scenario. No significant impact upon *Upogebia africana* occurred and the response to this scenario is similar to that for the present run-off scenario.

6. *The intermediate run-off scenario (20% of the natural MAR)*

The axial salinity gradient exceeds the minimum recruitment requirement on two occasions, allowing recruitment in both November/December and late March. As a consequence two periods of maximum recruitment occur, resulting in a mean annual score of 18 (Figure 4.30). The salinity conditions result in a slightly higher production for *Upogebia africana* than all of the preceding run-off scenarios other than the natural run-off condition (Figure 4.30).

(a)

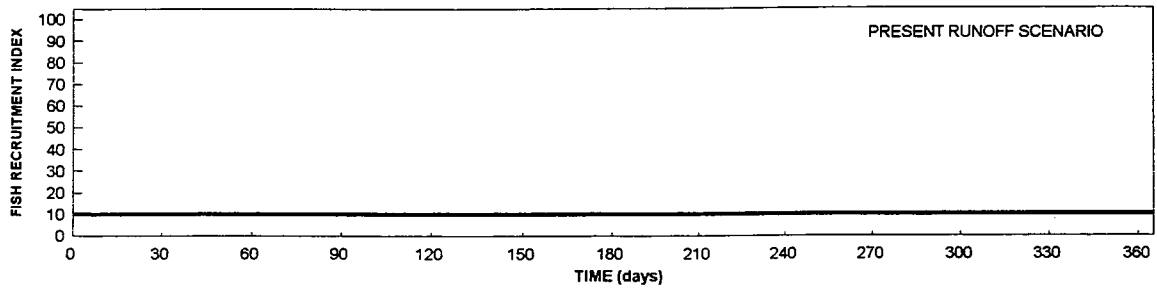

(b)

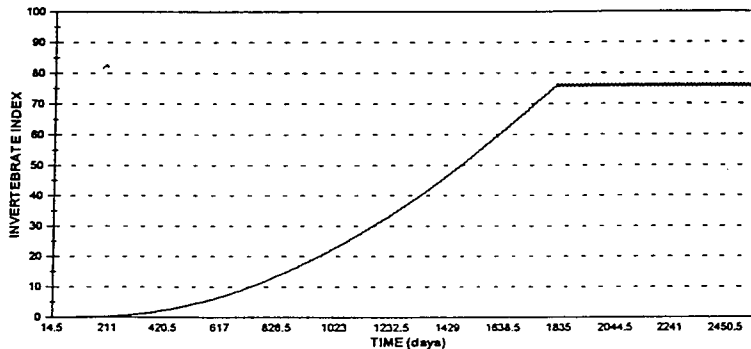

Figure 4.27 The fish recruitment index (a) and the invertebrate production index (b) under the present run-off scenario

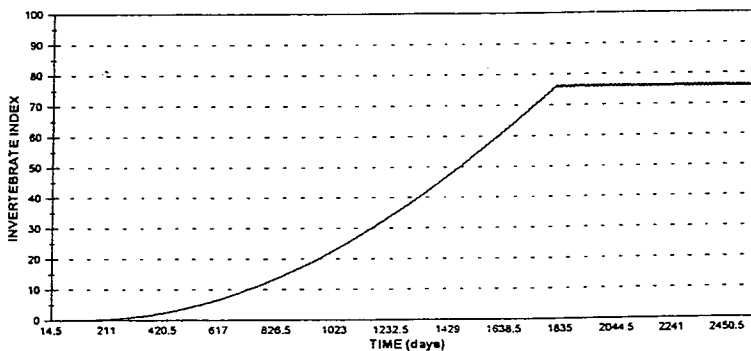

Figure 4.28 The invertebrate production index under the run-off scenario 4a

7. The intermediate run-off scenario (40% of the natural MAR)

Under this run-off scenario, axial salinity differences greater than 20 ppt are maintained for longer periods of time and consequently the mean annual score is 48 (Figure 4.31). The salinity conditions are more favourable to the mud prawn, resulting in a slightly higher production of *Upogebia africana* than under all run-off scenarios other than the natural run-off condition (Figure 4.31).

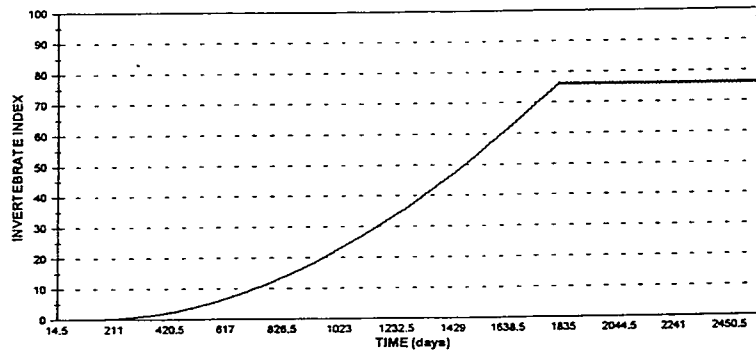

Figure 4.29 The invertebrate production index under the intermediate run-off scenario 4b

(a)



(b)

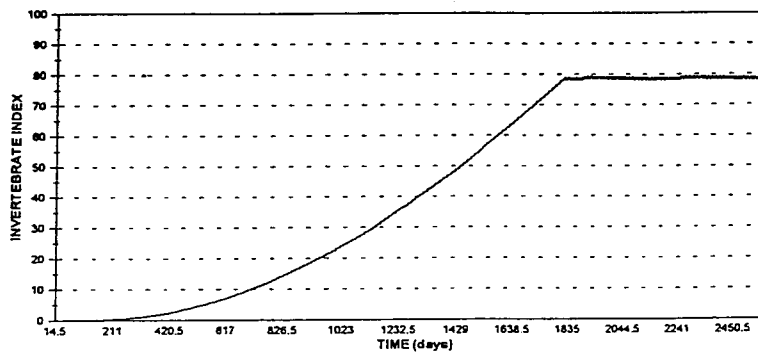

Figure 4.30 The fish recruitment index (a) and the invertebrate production index (b) under the run-off scenario 6

8. *Disturbance scenario : No freshwater flow to the estuary for three years*

Deprivation of freshwater results in very low recruitment of any dependent fish species, although the production of *Upogebia africana* is not seriously impaired, and is comparable with scenarios 3 to 6.

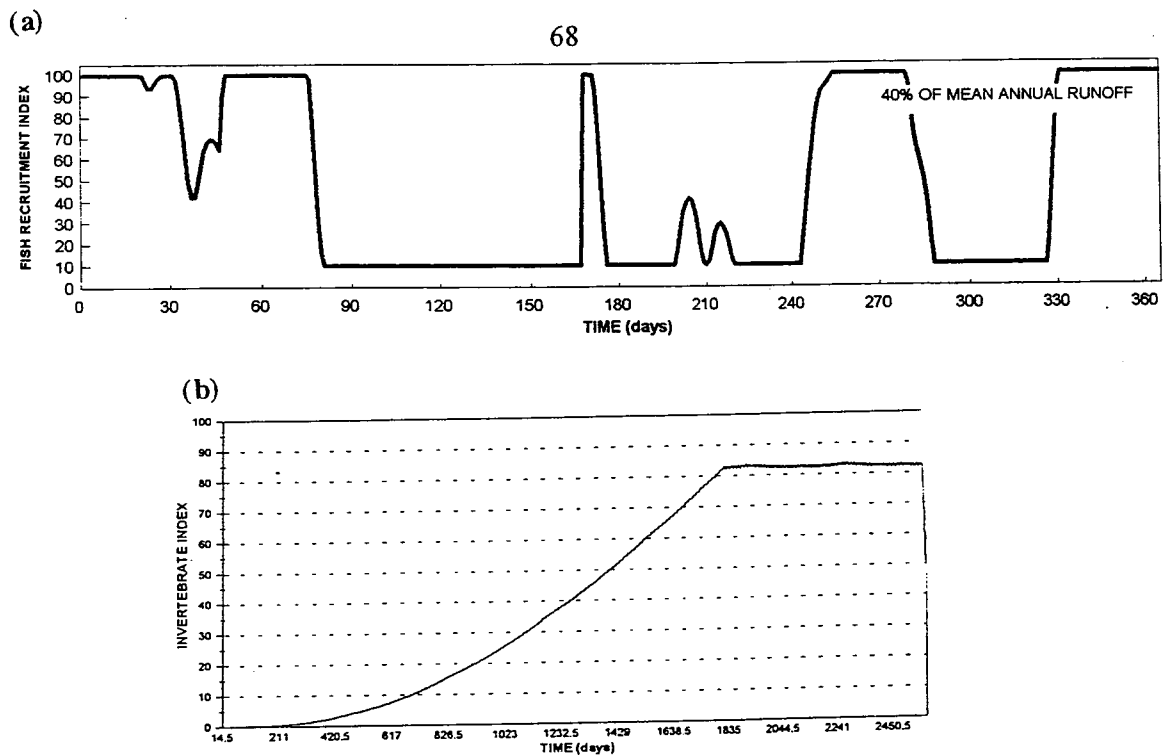

Figure 4.31 The fish recruitment index (a) and the invertebrate production index (b) under the run-off scenario 7

The results of the Estuarine Ecosystem Evaluation Model are summarised in Table 16.

Table 16 Summary of results of the Estuarine Ecosystem Evaluation Model

SCENARIO	FISH RECRUITMENT INDEX	INVERTEBRATE PRODUCTION INDEX	
	<i>mean</i>	<i>mean</i>	<i>maximum</i>
1	87	47.66	91.58
2	15	40.18	78.11
3	10	39.41	76.52
4a	-	39.47	76.68
4b	-	39.44	76.59
4c	-	39.43	76.56
4d	-	39.41	76.54
5	-	39.31	76.34
6	18	40.91	79.46
7	48	43.37	83.79
8	5	39.41	76.34

Model Limitations and Range of Application

The fish recruitment index integrates current understanding of the key processes regulating recruitment into estuaries, incorporating the extent of dependence of 26 common estuarine species, the presence or absence of required salinity gradients and the status of the mouth. The simulations are considered representative of anticipated responses of fish to a reduction in freshwater inflow to estuaries, despite a lack of quantitative data on which to validate simulation results.

The results of the predictions for the invertebrate production index (*Upogebia africana*) are disappointing. The reasons for this are firstly, that the mouth of the Kromme is permanently open, thus allowing the opportunity for continuous recruitment throughout the year. Secondly the production (growth rate) and mortality of *Upogebia africana* within the estuary are dependent on the combined effects of temperature and salinity. As temperature variations were not modelled, growth and mortality were related only to changes in salinity. The effects of salinity on the growth and mortality rates is significant at high (> 34 ppt) and low (< 7 ppt) salinities and the temperature prevailing at these salinities is a major determinant of the severity of the consequences to the mud prawn population. A contributing factor is that hypersalinities are not well predicted by the Estuarine Systems Model, the results from which feed directly into the EEEM. However, hypersalinities are well predicted by Mike 11. This inadequacy and the omission of temperature from the modelling process affected the usefulness of *Upogebia* as an indicator of ecosystem functioning in the Kromme Estuary.

This case study has highlighted the following key points :

- Although both indices have performed adequately, the fish recruitment index is a better predictor of faunal response than the invertebrate production index for estuaries with a permanently open mouth.
- If the invertebrate production index is to be used with any confidence in situations where salinities are often in the vicinity of *Upogebia africana*'s limits of tolerance, temperature effects and hypersalinities must be simulated adequately.

4.4.4 Summary

The Estuarine Systems Model was successfully applied to the problem of predicting the response of the physical environment of the Kromme Estuary to different freshwater inflow scenarios. The effects on water levels, tidal fluxes, flushing of the estuary, salinities, stratification and the sill height at the mouth were predicted, but prediction of the occurrence of hypersalinities is not accommodated in the model. These results together with Mike 11 predictions were used in the prediction of the vegetation response by the Dynamic Vegetation Model and the faunal response

by the Estuarine Ecosystem Evaluation Model. Results from the Dynamic Vegetation Model bear out the qualitative predictions from PEDSSys for the most part. This is particularly true for the prediction of the response of *Zostera* to the natural run-off situation as opposed to those run-off scenarios where 10% of the natural MAR or less is supplied to the estuary per annum. Results from the Ecosystem Evaluation Model indicate that fish recruitment is severely affected by strong reductions in freshwater flow with only those scenarios receiving freshwater flows equivalent to 10% of the natural MAR and greater, experiencing significant recruitment. The invertebrate production index proved a disappointing indicator of ecosystem functioning for the permanently open Kromme Estuary, particularly as combined temperature-salinity conditions in the estuary were not modelled. However, the utility of a long term modelling approach was demonstrated by the application of disturbance scenarios as undertaken with the Dynamic Vegetation Model, because this highlights resilience aspects of the ecosystem state under the different inflow scenarios rather than just simulating the response of components of the system.

5. IMPLEMENTING MODEL LINKAGES: THE GREAT BRAK CASE STUDY

To test the linked modelling system further it was also applied to a small, temporarily open system, the Great Brak Estuary. Although the Great Brak Estuary was selected as the first case study, the results are presented after those of the Kromme Case Study for the sake of clarity. The complementary nature of the different modelling approaches will be highlighted through this application. Test run-off scenarios were generated to reflect real management decisions made either in the past or fairly recently.

5.1 The Great Brak Estuary

The Great Brak Estuary is a small intermittently closed system located about 24 km to the east of Mossel Bay on the southern Cape coast. Precipitation in this area occurs uniformly throughout the year with slight peaks in spring and autumn. However, recorded annual run-off figures over a nineteen year period show considerable variation from a minimum of $4.3 \times 10^6 \text{ m}^3$ in 1979/1980 to a maximum of $44.5 \times 10^6 \text{ m}^3$ in 1962/63. In 1989 the construction of the Wolwedans Dam, with a capacity of $23 \times 10^6 \text{ m}^3$, was completed. The location of this impoundment approximately 3 km upstream of the head of tidal influence of the estuary, ensures that much of the run-off to the system is curtailed.

The Great Brak Estuary is 7.4 km in length. Informal development has occurred in the upper reaches of the estuary and formal developments exist on the Island and in Great Brak Town (Figure 4.1). Flooding of low-lying developments occurs from water levels of 1.88 m to MSL and is a concern when the mouth of the estuary closes. The major determinant of the physical dynamics of the Great Brak Estuary is the state of the mouth, that is, whether the mouth is closed or open and, if open, to what extent and with what frequency. Relevant data in this regard include field observations of mouth openings and closures and associated water level variations in the estuary from May 1988 to the present and simulated run-off data for a 64 year period under the anticipated natural, pre-dam and the post-dam situations.

When the mouth of the estuary is open strong tidal variations occur over spring tides, but there is little or no variation over neap tides. The low water levels rarely drop below 0,6 m to MSL and normally occur at neap tides. High water at spring tides rises to about 1,10 m to MSL, but an exceptional level of 1,80 m to MSL has been recorded when the equinoxial spring tide of 26 September 1988 co-incident with high waves in the sea. Neap tidal fluxes are often close to zero, whereas spring flood tidal fluxes normally do not exceed $20 \text{ m}^3 \cdot \text{s}^{-1}$ and ebb tidal fluxes normally are less than $10 \text{ m}^3 \cdot \text{s}^{-1}$. Typical flood and ebb tides are of 4 and 8,5 hour duration, respectively.

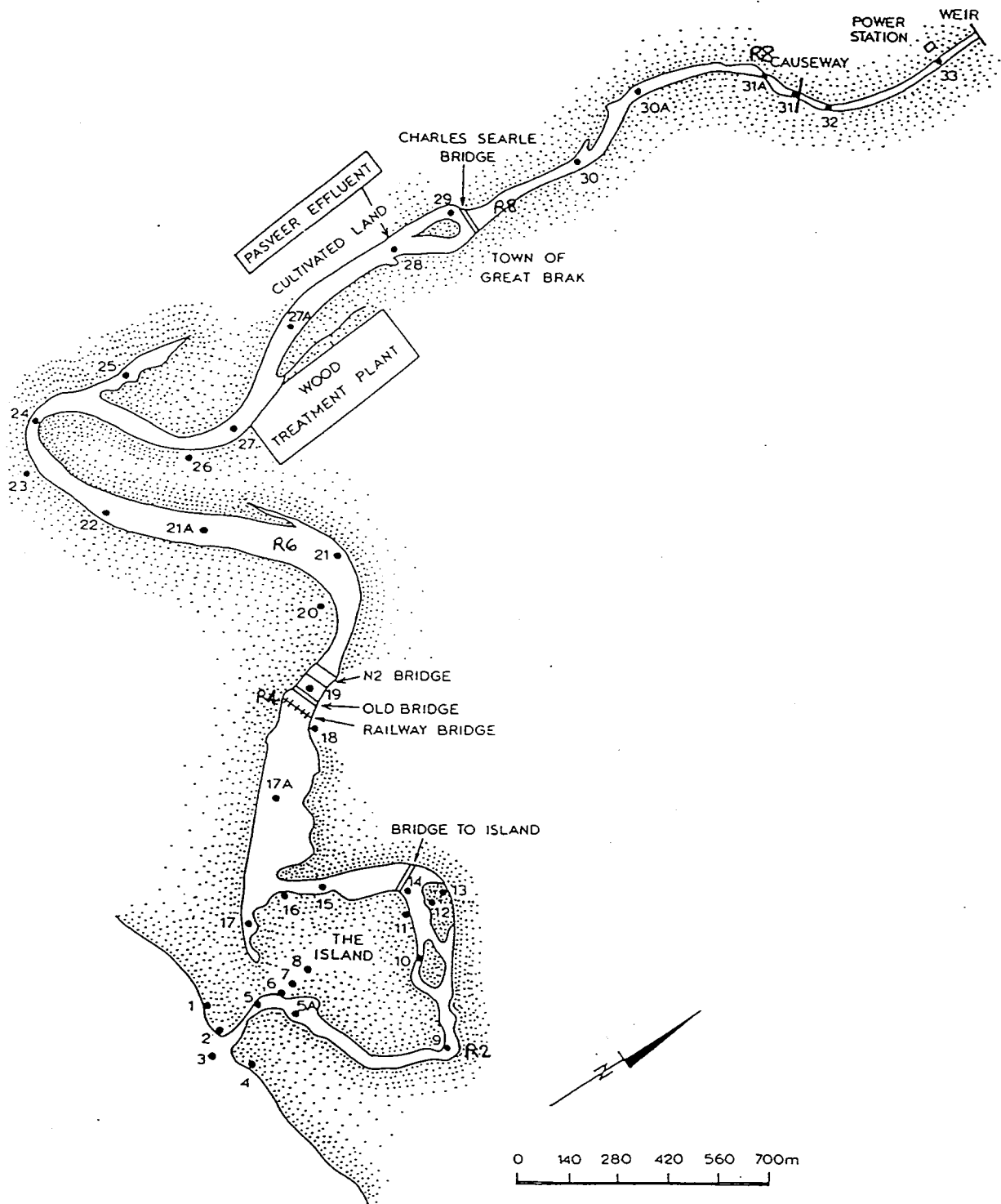

Figure 5.1 Map of the Great Brak Estuary, the selected case study site. Note the positions R2, R4, R6, R8 (4,78 & 5,44 km) for which Mike 11 water level and salinity simulation data were provided.

5.2 Run-off Scenarios for Estuarine Model Applications to the Great Brak Case Study

The Great Brak Estuary is presently assured of $2 \times 10^6 \text{ m}^3$ per annum, which is 6% of the run-off it would have received under natural conditions. On average, however, the run-off to the estuary well exceeds this figure owing to overflow from the Wolwedans Dam and run-off from the area of catchment situated downstream of the dam. In applying the linked modelling approach to the estuary a range of inflow scenarios was selected based on the available data and with the purpose of indicating the effects of the reduction in freshwater flow to the estuary. Although the option of pumping of seawater into the Great Brak Estuary with the objective of enhancing scour of sediment at the mouth during breachings and over neap tides was proposed for inclusion in the study, this was not considered sufficiently representative for inclusion. The run-off scenarios finally selected were:

1 *The natural run-off scenario*

The estimated natural (pristine) condition was included as a run-off scenario, despite a lack of quantitative data, because it provides a reference point from which the change in estuarine condition can be evaluated as a consequence of changes in run-off to the estuary. The MAR under natural conditions is $34 \times 10^6 \text{ m}^3$. It is anticipated that under the natural run-off scenario the mouth would have remained open all year between 25 and 50 per cent of the time. A closed mouth would have occurred on average for between one and two months per year, but rarely would the mouth have remained closed for more than one month at a time. Water levels higher than 2,00 m to MSL would have occurred occasionally.

2 *The pre-dam run-off scenario*

Changes in the catchment such as afforestation and the construction of many small farm dams, as well as the adoption of a breaching policy at the mouth, are the major contributing factors to the diversion of the pre-dam run-off situation from the natural condition. The MAR under pre-dam conditions is $24 \times 10^6 \text{ m}^3$ (Bruwer 1989). Based on run-off and mouth closure information for the period 1987 to date, it is anticipated that under the pre-dam run-off scenario the mouth would have been open, on average, for between 50 and 75 % of the time. During dry periods the mouth sometimes would have remained closed for 3 to 5 months at a time. Water levels as high as 1,95 m + MSL might have occurred, despite artificial breaching being undertaken when a danger of flooding was perceived. Breaching began when a water level of 1,62 m + MSL was reached, but did not always result in an immediate decrease in the water level.

3 *The post-dam run-off scenario*

The MAR under pre-dam conditions is $10 \times 10^6 \text{ m}^3$ (Bruwer 1989), although the assured allocation to the estuary at present is $2 \times 10^6 \text{ m}^3$. It is anticipated that the estuary mouth will be open, on average, for between 30 % and 50 % of the time. About once in every 4 years the mouth will be open between 1 and 3 months. Overflow from the dam will not occur. However, the timing of the open mouth conditions and the water releases may be planned optimally. Water levels substantially higher than 1,8 m + MSL are unlikely as efficient mouth breaching operations will be undertaken at levels between 1.62 m to MSL and 1.88 m to MSL. Two simulation scenarios are considered under the post-dam run-off situation:

- (a) An annual freshwater inflow of $10 \times 10^6 \text{ m}^3$, distributed as seasonal base flow,
- (b) An annual freshwater inflow of $2 \times 10^6 \text{ m}^3$, distributed as seasonal base flow.

Additionally, the effects of perturbations to the estuarine states arising from the imposition of inflow scenarios 1 to 3 can be investigated by considering disturbance scenarios. The disturbance scenarios selected for the Great Brak Case Study are:

- A. The imposition of a flood equivalent to the 1 in 50 yr flood volume for each of the run-off scenarios
- B. A decrease of 50 % in the freshwater inflow to the estuary over the period March to June.

5.3 Implementing Short Term Prediction on the Great Brak Case Study

5.3.1 **The Mike 11 Hydrodynamic and Transport-Dispersion Model**

A simulation period of 28 days was selected for application of the Mike 11 hydrodynamic and transport-dispersion model. The simulations began at spring tide and encompassed two spring-neap tidal cycles. The boundary condition at the mouth was taken as the water level variation 0,51 km inside the estuary in all model runs, that is the mouth was assumed open. Various freshwater discharge rates were used as the upstream boundary conditions for the different simulation runs. Water levels, volume fluxes, velocities and average vertical salinities at five positions along the length of the estuary were simulated.

Calibration of the model results was achieved through comparison with recorded water level variations and salinity distributions in the estuary under similar freshwater flows and mouth conditions (CSIR 1990).

Model Results

The mean annual run-off under the *natural run-off scenario* is $36 \times 10^6 \text{ m}^3$. This condition was approximated by a constant, average freshwater inflow of $1,14 \text{ m}^3 \cdot \text{s}^{-1}$ and the resultant salinity distribution is presented at hourly intervals over the 28 day simulation period (Figure 5.2). The greatest variation in salinities occurred in the lower estuary (R2) with salinities of 35 ppt prevailing over spring flood tides and salinities of about 5 ppt occurring at the end of the neap tide (days 1/12 and 15/12). Salinities in the middle reaches (R6) exhibited less variation, averaging 10 ppt over spring tides and around 3,5 ppt over neap tides, once the effect of the initial condition of 32 ppt had dissipated. Salinities in the upper reaches of the estuary were less than 5 ppt (R8) and 3 ppt (R8) from the third day onwards, that is the upper reaches reflected strong freshwater influence once the effect of the chosen initial condition of the simulation run had dissipated. However, the elevation of salinities in the estuary over the spring tidal period and the decline in salinities over neap tides is a clear feature of the lower and middle reaches of the Great Brak Estuary. A similar feature is evident in the water levels with strong variation (0.4 m) occurring over spring tides and almost no variation over neap tides. The water level rarely falls below 0.7 m to MSL over the majority of the estuary. Under the natural run-off scenario, the upper estuary exhibits seaward flow throughout the spring neap tidal cycle. Only in the middle and lower reaches do bi-directional flows occur.

The mean annual run-off under the *pre-dam run-off scenario* is $24 \times 10^6 \text{ m}^3$. The effect of this run-off scenario on salinities in the estuary was approximated very roughly by assuming a constant, average inflow of $0,76 \text{ m}^3 \cdot \text{s}^{-1}$ (a typical flow condition under this run-off scenario). The simulated salinities at four positions in the estuary are presented in Figure 5.3. It is noticeable that the variation in salinities in the lower and middle reaches of the estuary is less than under the natural run-off scenario. At R2 salinities vary between 35 ppt and about 17 ppt over spring tide and remain above 9 ppt even over neap tides. Salinities in the middle reaches are higher on average than under the natural run-off scenario. For instance, the average over neap tides is 8 ppt and greater and under spring tides is 13 ppt and greater. Salinities in the upper reaches still reflect considerable freshwater influence, remaining less than 6 ppt after the first five days of the simulation. The water level variations under the pre-dam and the natural run-off scenarios are very similar. Only in the upper reaches may differences be distinguished in that the tidal variation is slightly greater under the reduced freshwater flow of the pre-dam run-off scenario. The flow direction in the upper reaches is always seaward and only at R6 do bi-directional flows occur.

A typical flow condition under the *post-dam run-off scenario* is assumed to be described by a freshwater discharge rate of $0,032 \text{ m}^3 \cdot \text{s}^{-1}$. Salinity distributions in the estuary with this freshwater inflow are presented in Figure 5.4. Once the effect of the selected initial condition for the

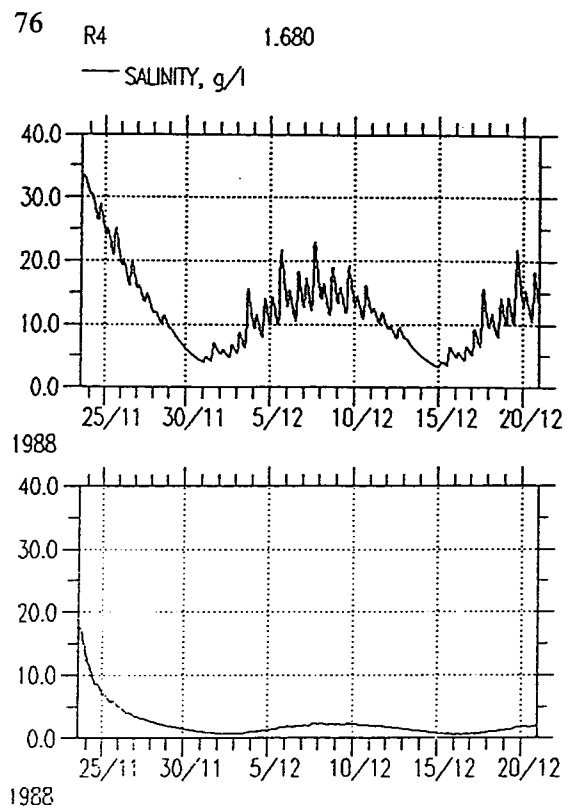
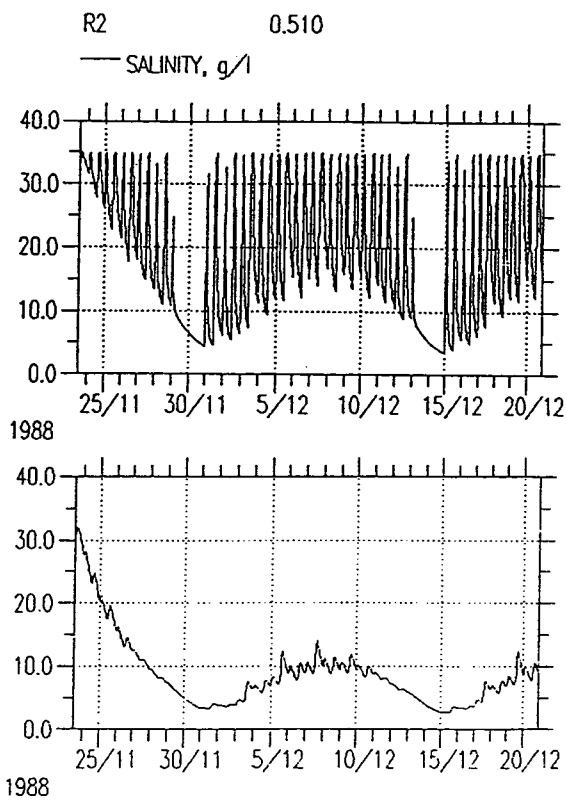

Figure 5.2 Salinities generated by Mike 11 at positions R2, R4, R6 & R8 over 28 days under the natural run-off scenario

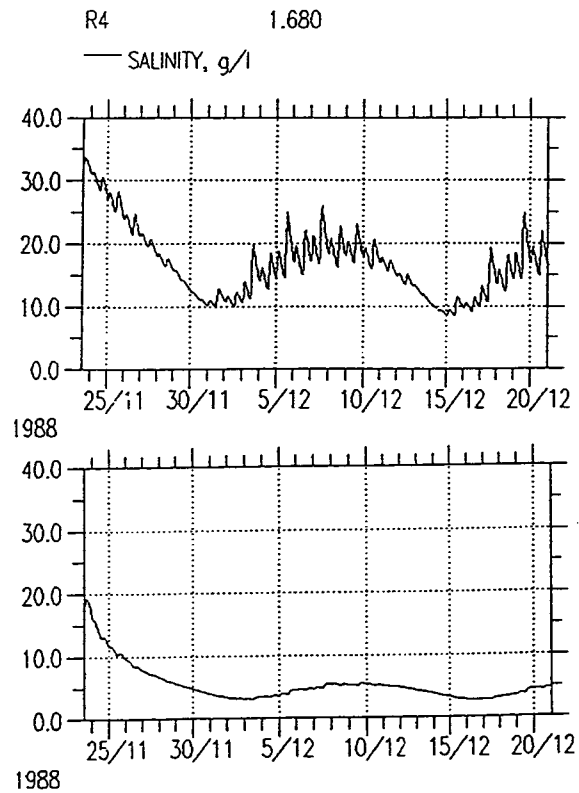
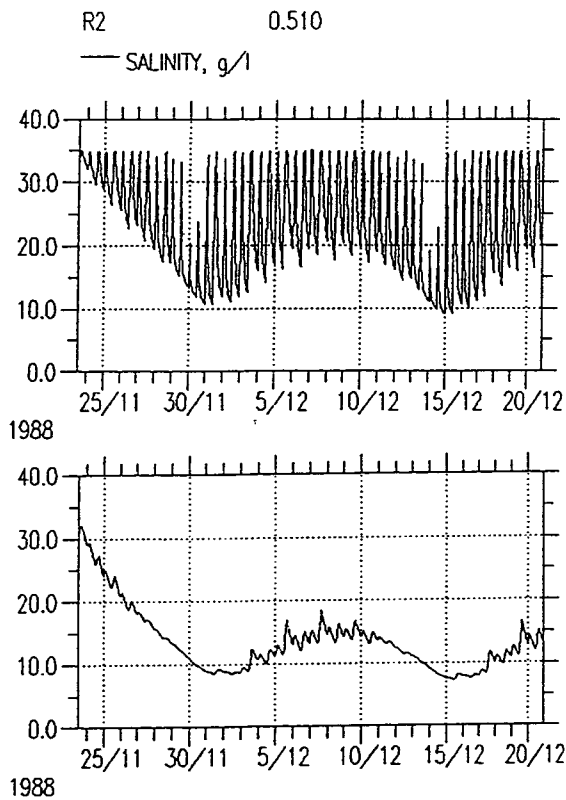

Figure 5.3 Salinities generated by Mike 11 at positions R2, R4, R6 & R8 over 28 days under the pre-dam run-off scenario

simulation has dissipated (i.e. after about 8 to 10 days), the variation in salinities in the upper and middle reaches of the estuary on flood and ebb tides and over spring and neap periods has declined drastically. Salinities greater than 30 ppt prevail throughout most of the estuary. The water level variations are very similar to those exhibited under the natural and pre-dam run-off scenarios, apart from in the upper reaches where tidal variation of amplitude 0.35 m is now a feature over spring tides. Additionally, the uni-directional character of the flow in the upper reaches has altered and very small or zero velocities generally occur. Clearly, releases of freshwater from the dam for the purpose of filling the estuary to breaching level and breaching the mouth will alter this typical highly saline state of the estuary, but these will be intermittent events imposed on a highly uniform estuarine state.

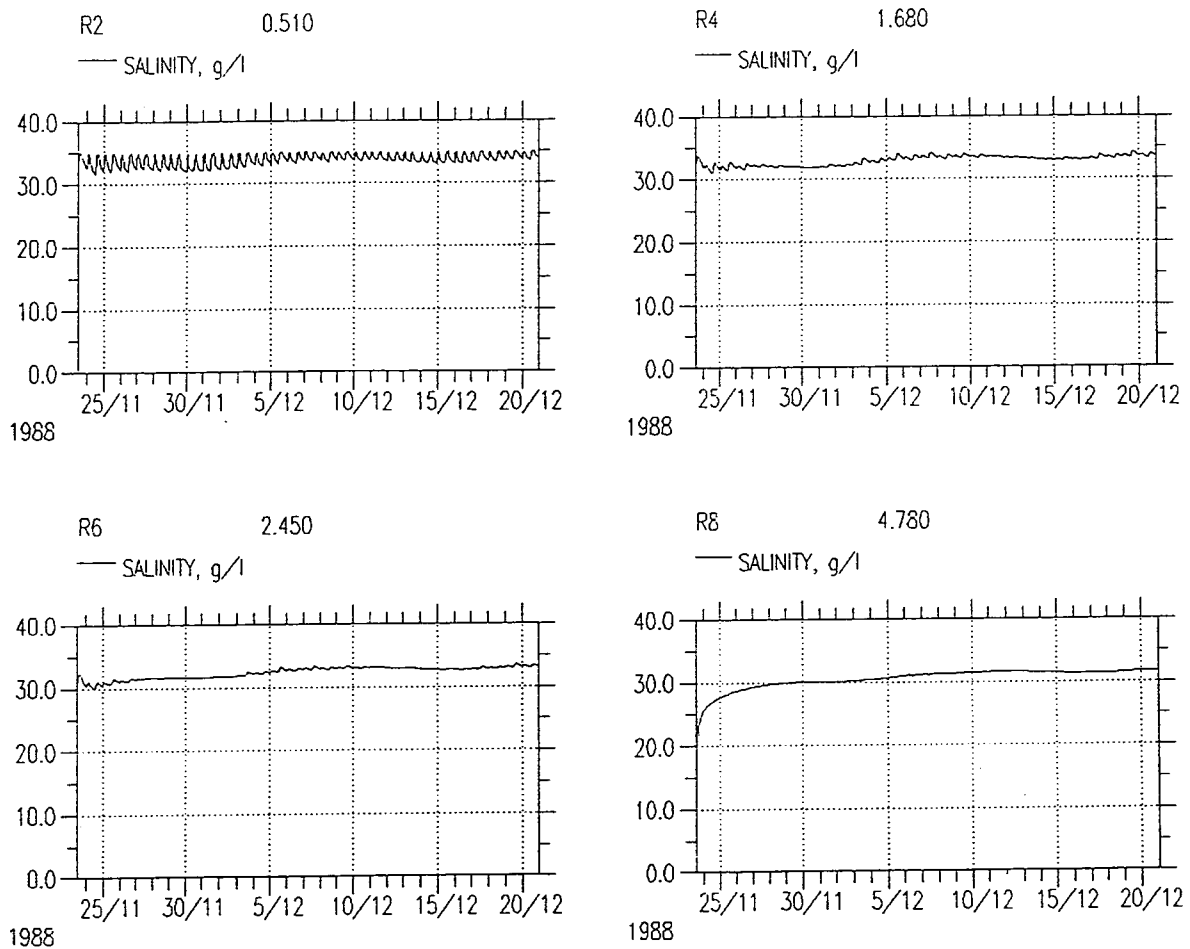

Figure 5.4 Salinities generated by Mike 11 at positions R2, R4, R6 & R8 over 28 days under the post-dam run-off scenario

In order to investigate the effects of a flood release on the salinity distributions in the Great Brak Estuary under each of the run-off scenarios, flood disturbance simulations were conducted. It was assumed that a major flood has occurred, flushing the estuary completely of salt. Thus the initial condition was that of zero salinity throughout the system. Under the post-dam run-off scenario, the effect of the flood was shortlived and salinities in the system had returned to their characteristic state within 15 days (Figure 5.5). Under both the natural and pre-dam run-off scenarios, the effect of the flood was still evident at the end of the 28 day simulation period (Figures 5.6 & 5.7). Salinities were near their characteristic levels, but were still recovering from the disturbance.

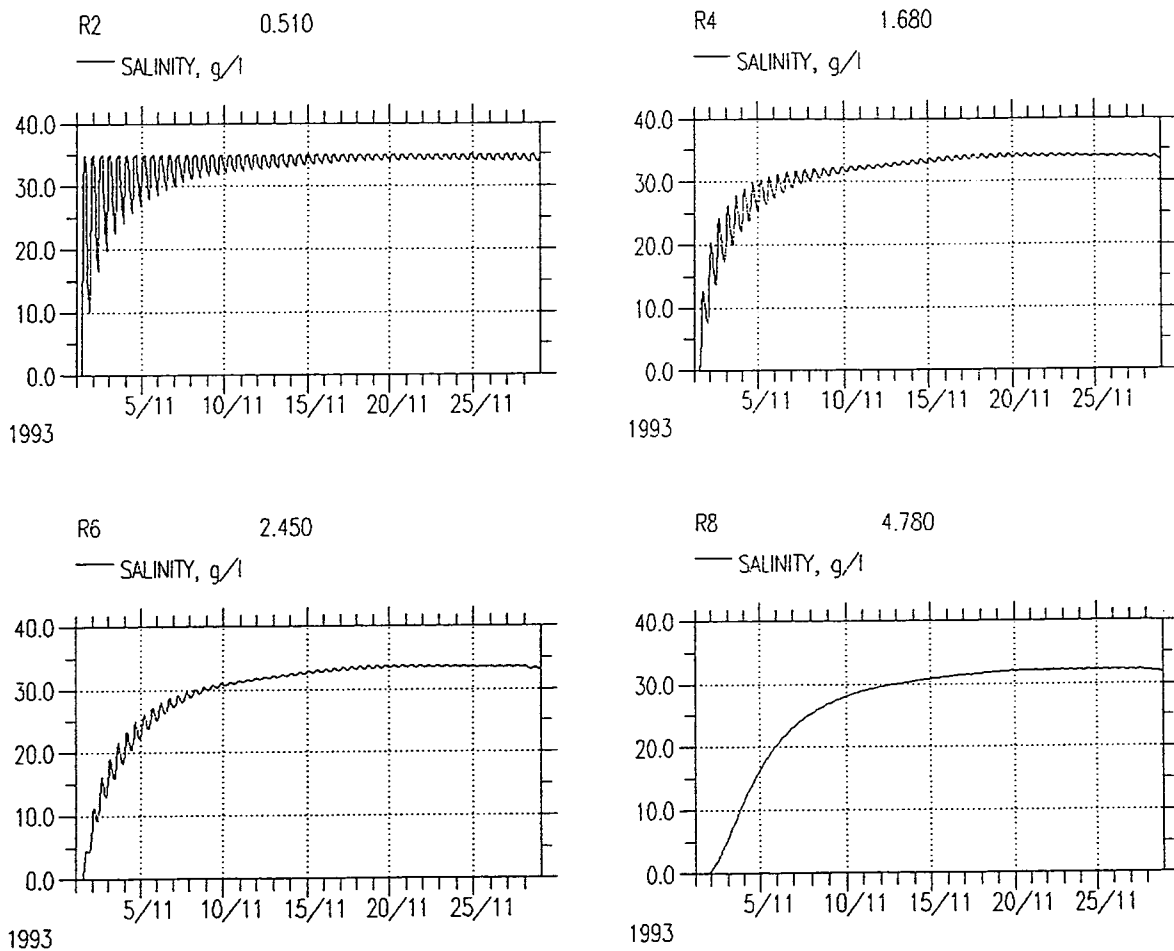

Figure 5.5 The intrusion of saline water into the Great Brak Estuary over a 28 day period after a flood event under the post-dam run-off scenario

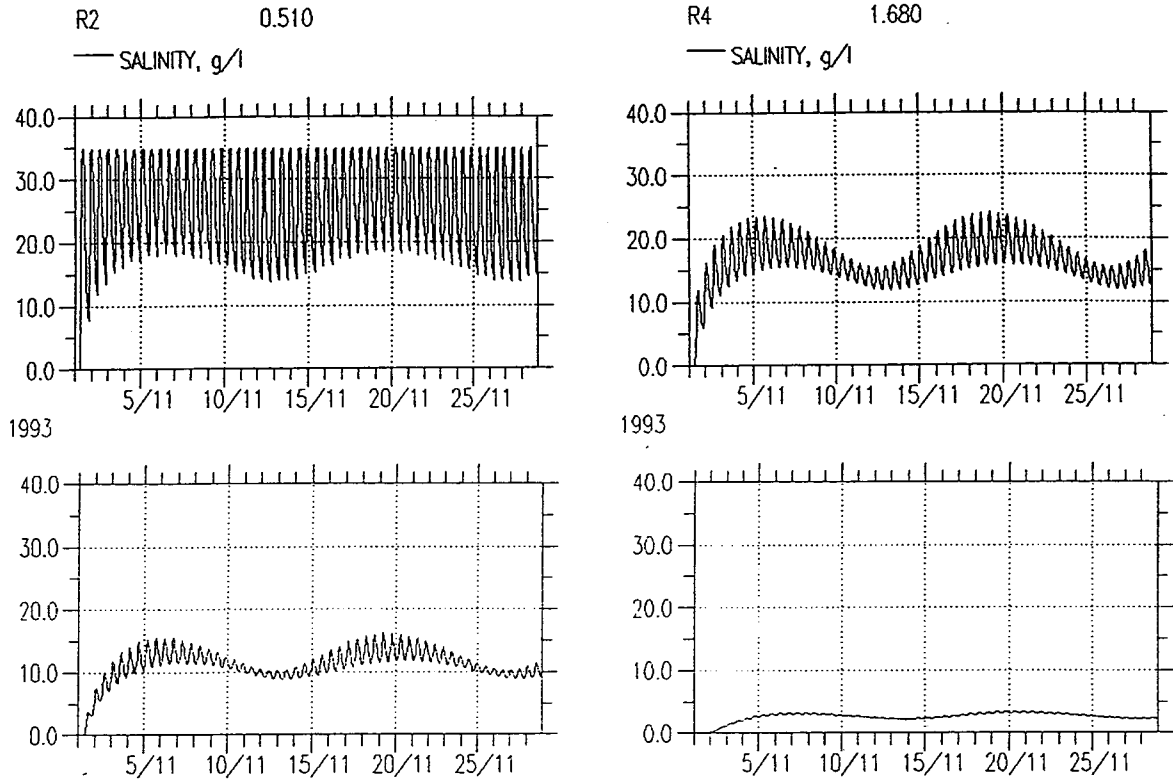

Figure 5.6 The intrusion of saline water into the Great Brak Estuary over a 28 day period after a flood event under the natural run-off scenario

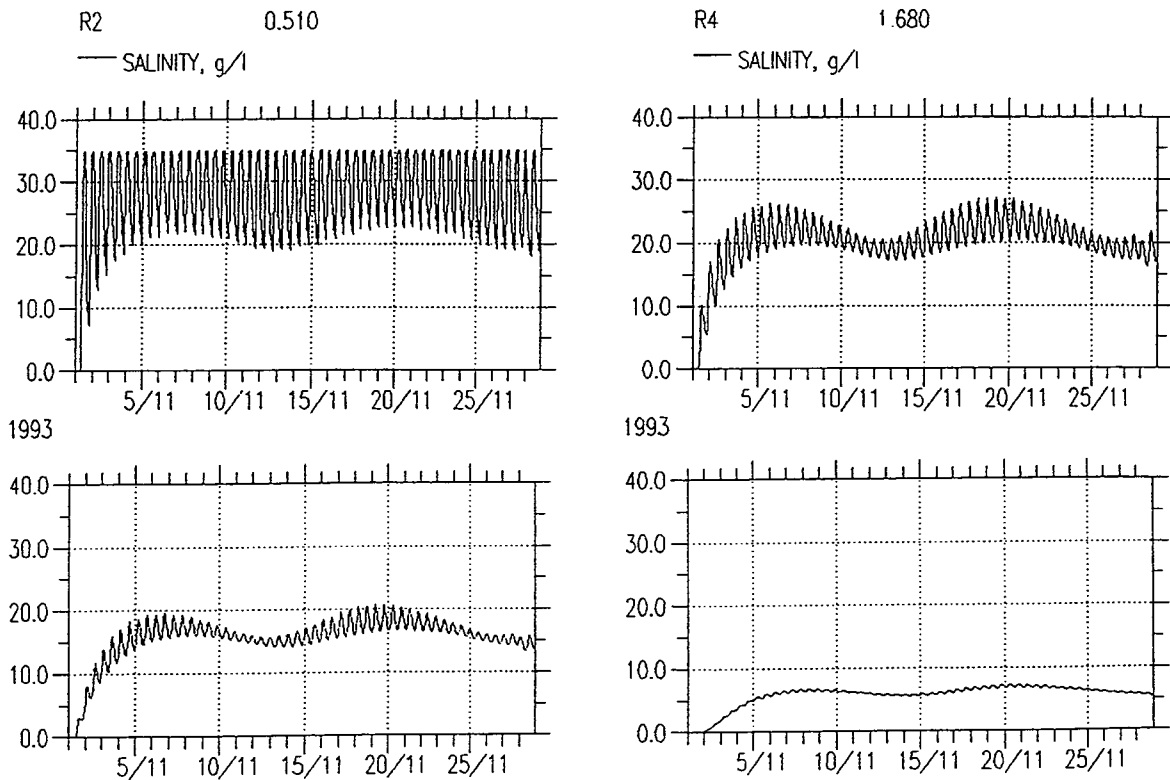

Figure 5.7 The intrusion of saline water into the Great Brak Estuary over a 28 day period after a flood event under the pre-dam run-off scenario

Model Limitations and Range of Applicability

The use of the Mike 11 one-dimensional hydrodynamic and transport-dispersion model in a temporarily closed system such as the Great Brak Estuary presents problems in that closure of the mouth cannot be simulated. Each simulation has to be conducted with either an open or a closed mouth. Thus Mike 11 cannot be used to investigate the time-dependent response of a macrophyte or faunal indicator species to events such as mouth closures and openings. This is rather the task of the ESM. However, the short term optimal use of Mike 11 is shown in the accuracy of the water levels, flows and salinities generated over the 28 day simulation period.

The output data supplied to the ecological models by Mike 11 comprised daily minimum and maximum water levels, tidal range, average salinity and maximum current velocity for five positions in the estuary, namely R2, R4, R6, R8 and R8 in Figure 5.1, over a twenty-eight day period.

5.3.2 The Mike 11 Water Quality Module

The decision was made to apply the Mike 11 Water Quality module to the Great Brak Estuary rather than using the Water Quality Systems Model developed by Mr A Ramm using the iTHINK modelling method. This approach was adopted, because it would facilitate linking to the hydrodynamics and aid in developing an understanding of the common features and/or an appreciation of the differences between the Mike 11 Water Quality Module and the iTHINK model.

Model Application Results

The coupled BOD-DO water quality module of Mike 11 was implemented on the Great Brak Estuary using default chemical reaction parameters. Calibration data were lacking, limiting the range of scenarios that could be simulated and constraining the validity of the results. In view of this limitation and the simulation time required by the water quality module, only two simulations are presented for discussion.

The results of two selected simulation runs are presented in Figure 5.8. In these diagrams, the profile of cross-sections extending from the mouth upstream for 5 km is illustrated. The curve overlaid on this profile represents the longitudinal variation in the depth-averaged dissolved oxygen concentrations of the Great Brak Estuary under medium freshwater flow conditions, characteristic of the pre-dam run-off scenario (constant inflow of $0,76 \text{ m}^3 \cdot \text{s}^{-1}$). The kinetic parameters for BOD first order decay (k_1) and sediment oxygen demand (SOD) were $k_1 = 0,6$ and $\text{SOD} = 1 \text{ gO}_2 \cdot \text{m}^{-2} \cdot \text{day}^{-1}$ in Figure 5.8a and $k_1 = 0,2$ and $\text{SOD} = 0 \text{ gO}_2 \cdot \text{m}^{-2} \cdot \text{day}^{-1}$ in Figure 5.8b.

The reaeration formula of O'Connor-Dubbins was used in both simulations. The boundary conditions for DO are 8 mg.l^{-1} in both cases.

Two features are apparent in both diagrams. First there is a characteristic peak in DO located 4 km upstream of the mouth. This co-incides with a constriction in the estuary channel associated with a bridge. The constriction causes an increase in average current velocities at this point (as modelled by the Mike 11 hydrodynamic model), resulting in significantly higher reaeration and thus higher transport of DO into the water. Secondly, there is a characteristic sag in DO concentrations downstream of this point, with the minimum concentrations located at about 2,5 km upstream of the mouth. The decrease in oxygen with distance downstream of the bridge arises from consumption due to BOD, whereas the higher dissolved oxygen levels nearer the mouth are ascribed to tidal mixing of the estuarine water with intruding well oxygenated seawater. The general shape of the figures is the same for both simulations. Figure 5.8a represents a case with moderate SOD rates and higher BOD decay rates than those associated with Figure 5.8b. The net result is DO concentrations generally lower than those of Figure 5.8b. These simulations are uncalibrated for DO and the results obtained, therefore, cannot be considered reflective of reality. Any practical use of this water quality modelling approach would have to involve field work to determine some parameters more accurately. For instance, experiments designed to measure BOD and SOD rates and a diurnal DO study to determine true photosynthesis, respiration and reaeration rates would have to be conducted. However, provided that this field work is undertaken, no problems are foreseen in the application of the Mike 11 Water Quality Module as the trends in the simulation output appear reasonable.

Model Limitations and Range of Applicability

As with the hydrodynamic and transport-dispersion modules of Mike 11, the computational time required for the water quality module to perform simulations is considerable. Thus, inadequate calibration data as well as the time required per simulation limited the range of scenarios that could be tested. Attention was focussed on testing the effects of alterations in the parameters mentioned above for one inflow condition and not for a range of inflow scenarios as originally planned. Some experimentation with parameters related to nitrification and photosynthesis was undertaken and yielded reasonable but uncalibrated results.

This modelling approach has other limitations besides a dearth of field data and lengthy computational times. For instance, stratification is not included in the model and vertically averaged dissolved oxygen concentrations are simulated. In estuaries where stratification plays a role in causing bottom water to become hypoxic and even anoxic (e.g. the Great Brak Estuary), this implies that the results are not truly representative of the prevailing situation.

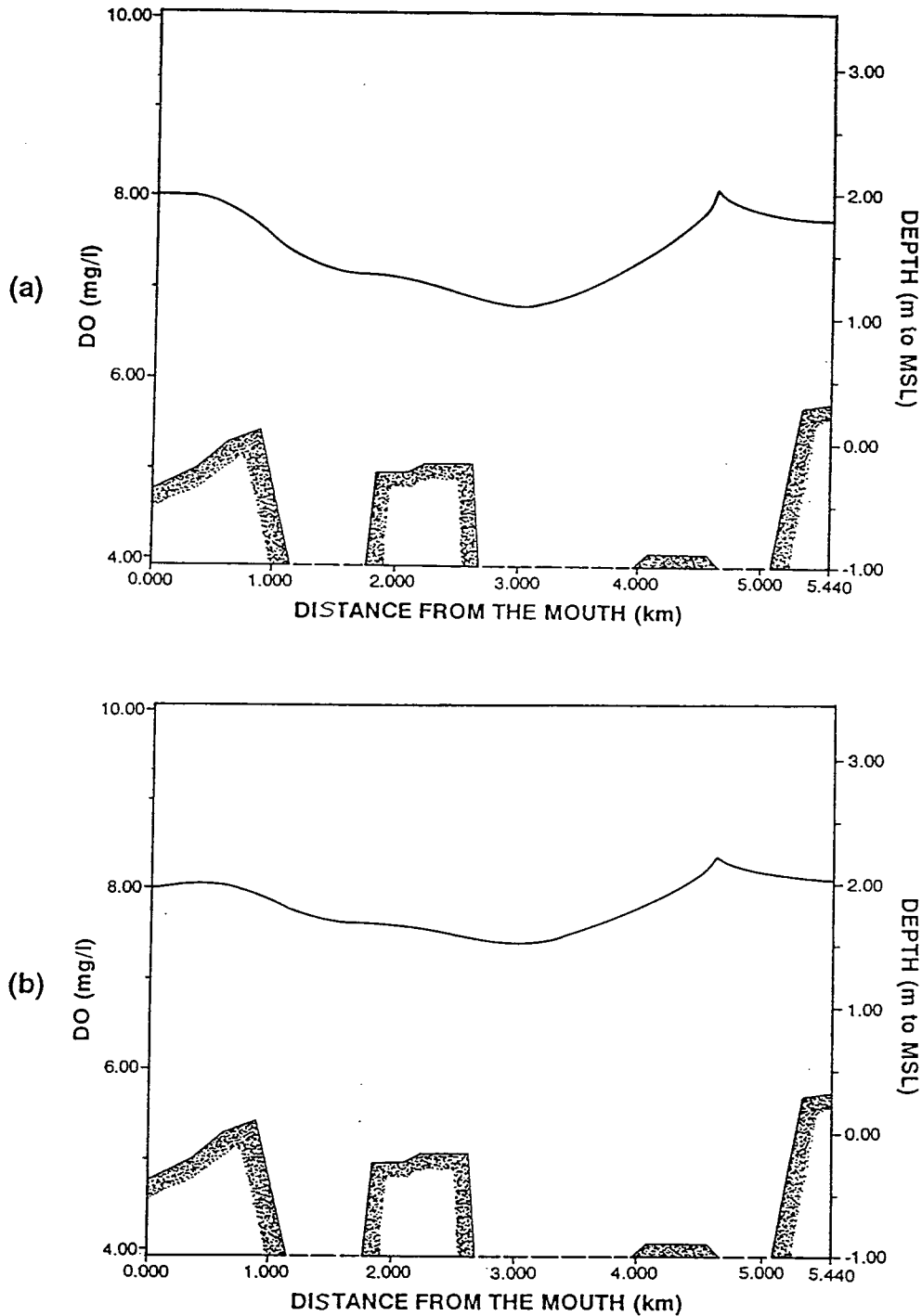

Figure 5.8 Average vertical dissolved oxygen concentrations simulated for the Great Brak Estuary under a freshwater flow of $0.76 \text{ m}^3 \cdot \text{s}^{-1}$, with parameter values for BOD decay and sediment oxygen demand set at $k_1 = 0,6$ and $\text{SOD} = 1 \text{ gO}_2 \cdot \text{m}^{-2} \cdot \text{day}^{-1}$ (a) and $k_1 = 0,2$ and $\text{SOD} = 0 \text{ gO}_2 \cdot \text{m}^{-2} \cdot \text{day}^{-1}$ (b).

The full range of applicability of the Mike 11 water quality module has not been explored adequately even for a small estuary such as the Great Brak. It is desirable that full testing should be carried out and in fact this should be extended to incorporate analysis of the applicability of the model to large, long systems eg. the Great Berg and Kromme Estuaries and to the lagoonal and lake systems for which the iTHINK model was developed.

There is potential to modify the iTHINK approach to include some of the Mike 11 modules e.g. bacterial contamination, nitrification and phosphate dynamics. In the period from July 1993 to March 1994, preliminary experimentation with this approach was conducted on the Little Amanzimtoti Lagoon in Natal, a system on which many data have been collected. Initial results indicate that such an approach is feasible. The key to interfacing the Mike II and iTHINK approaches to water quality modelling is in the recognition of their complementary nature. A one month simulation using the iTHINK model will run for approximately 15 minutes, whereas Mike 11 would take several hours. However, Mike 11 is much more sophisticated and hydrodynamically more accurate. Thus the iTHINK approach could be used optimally in scoping and early problem identification, applying the default chemical reaction parameters from Mike 11 where necessary. Thereafter, the biochemical kinetic parameters could be transferred to Mike 11 for more complex and accurate simulations.

5.3.3 The Estuarine Systems Model

The three run-off scenarios were translated into simulation scenarios for the application of the Estuarine Systems Model as follows:

- the freshwater inflows to the estuary under the natural, pre-dam and post-dam (a & b) scenarios were distributed as continuous, seasonally varying base flows of average magnitude $1.14 \text{ m}^3 \cdot \text{s}^{-1}$, $0.76 \text{ m}^3 \cdot \text{s}^{-1}$, $0.32 \text{ m}^3 \cdot \text{s}^{-1}$ and $0.063 \text{ m}^3 \cdot \text{s}^{-1}$, respectively,
- a sea tidal signal comprising both the semi-diurnal and spring neap variations characteristic of the Mossel Bay area formed one of the downstream boundary conditions,
- high wave events resulting in closure of the estuary mouth were assumed to occur in the low flow month of June under the natural run-off scenario, in May and December under the pre-dam run-off scenario and in November, February, April and July under the post-dam run-off scenarios, and
- Mouth breaching occurred naturally at levels of 1.95 m to MSL and greater under the natural run-off scenario, but was undertaken artificially at levels between 1.62 and 1.95 m to MSL under the pre-dam run-off scenario depending on the duration of the mouth closure event and the season and occurred at levels of 1.62 m to MSL and less under the post-dam run-off scenario depending on the duration of the event, the degree of inundation of marsh plants and the season.

Each simulation was undertaken for a period of at least two years beginning at the start of the hydrological year (1 October) and generating output at intervals of about one hour. Calibration of the model was undertaken by initially comparing recorded water level observations and those generated by the ESM, next quantitative calibration of the water level variation and the tidal fluxes was achieved by comparison with measurements and Mike 11 predictions under the same inflow and mouth conditions. Data from the flood release of 29 and 30 November 1990 (CSIR 1992) were used in the calibration of the salt sector of the model and the salinities predicted by Mike 11 were used to confirm the calibration of the mean salinity and axial salinity differences generated by the ESM. The stratification-circulation state and the flushing sector of the model were calibrated using data from field observations (Slinger *et al.* 1994). The sediment sector was calibrated last using the aforementioned field observations together with bathymetric surveys of the estuary mouth immediately prior and post a flood event and water level recordings over mouth closure events from 1988 to date.

Model Results

1. *The natural run-off scenario*

Water levels simulated by the ESM exhibit features characteristic of the middle reaches of the estuary with minima of about 0.68 m to MSL over neap tides and maxima of 0.92 m to MSL over spring high tides (Figure 5.9). When the mouth closes in June, the water level rises rapidly to a level of 1.95 m to MSL and the mouth breaches naturally. Mean salinities decline over the period of mouth closure to below 3 ppt. On spring high tides mean salinities between 18 and 25 ppt occur, whereas at the end of the neap tide period salinities average less than 3 ppt. The head to mouth differences in salinity are always 35 ppt under the strong freshwater flows of the natural run-off situation, indicating that the upper reaches of the estuary are brackish. The stratification-circulation state of the estuary is partially mixed. Tidal fluxes at the mouth achieve maxima of about $12 \text{ m}^3 \cdot \text{s}^{-1}$ on the flood tides, but the current speeds average about $1 \text{ m} \cdot \text{s}^{-1}$ in the mouth itself. Under the natural run-off situation the tidal flushing variable exhibits maxima of about 500 yr^{-1} and a near zero minimum when the mouth is closed.

2. *The pre-dam run-off scenario*

Water levels in the estuary are very similar to those under the natural run-off scenario during open mouth phases. However, under the pre-dam run-off scenario the mouth closes twice per year. When the mouth closes, water levels gradually increase (Figure 5.10) until artificial breaching of the mouth is undertaken. In summer this occurs at a level of 1.62 m to MSL and is undertaken within two weeks of water levels of 1.22 m to MSL being attained. This is because summer is the growing season for certain salt marsh species, which are inundated at levels higher than 1.22 m to MSL, and because it is important that the migration of fauna through the mouth

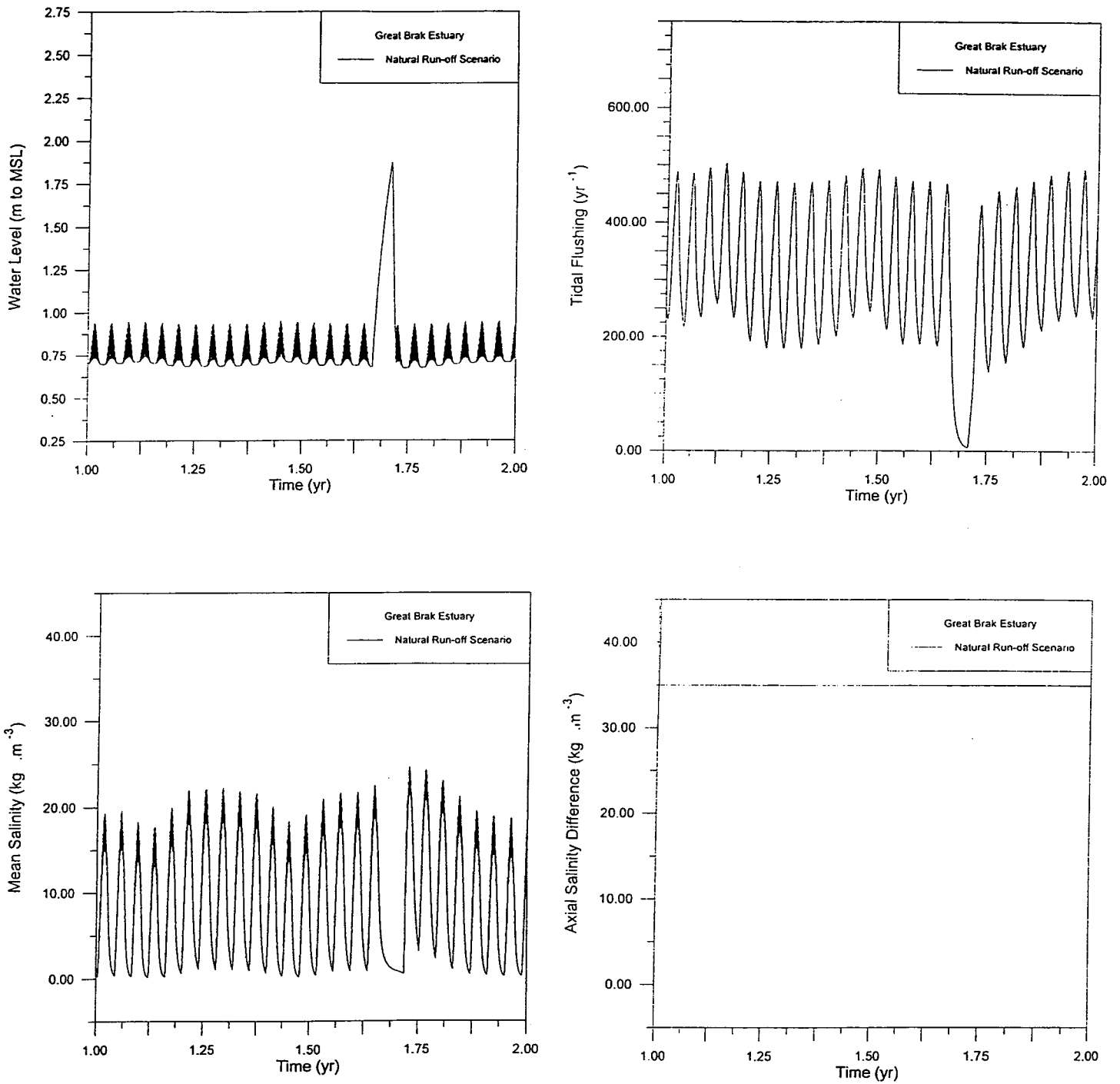

Figure 5.9 Water levels (top left), tidal flushing (top right), mean salinities (bottom left) and axial salinity differences (bottom right) simulated by the ESM over years 1 to 2 under the natural run-off scenario.

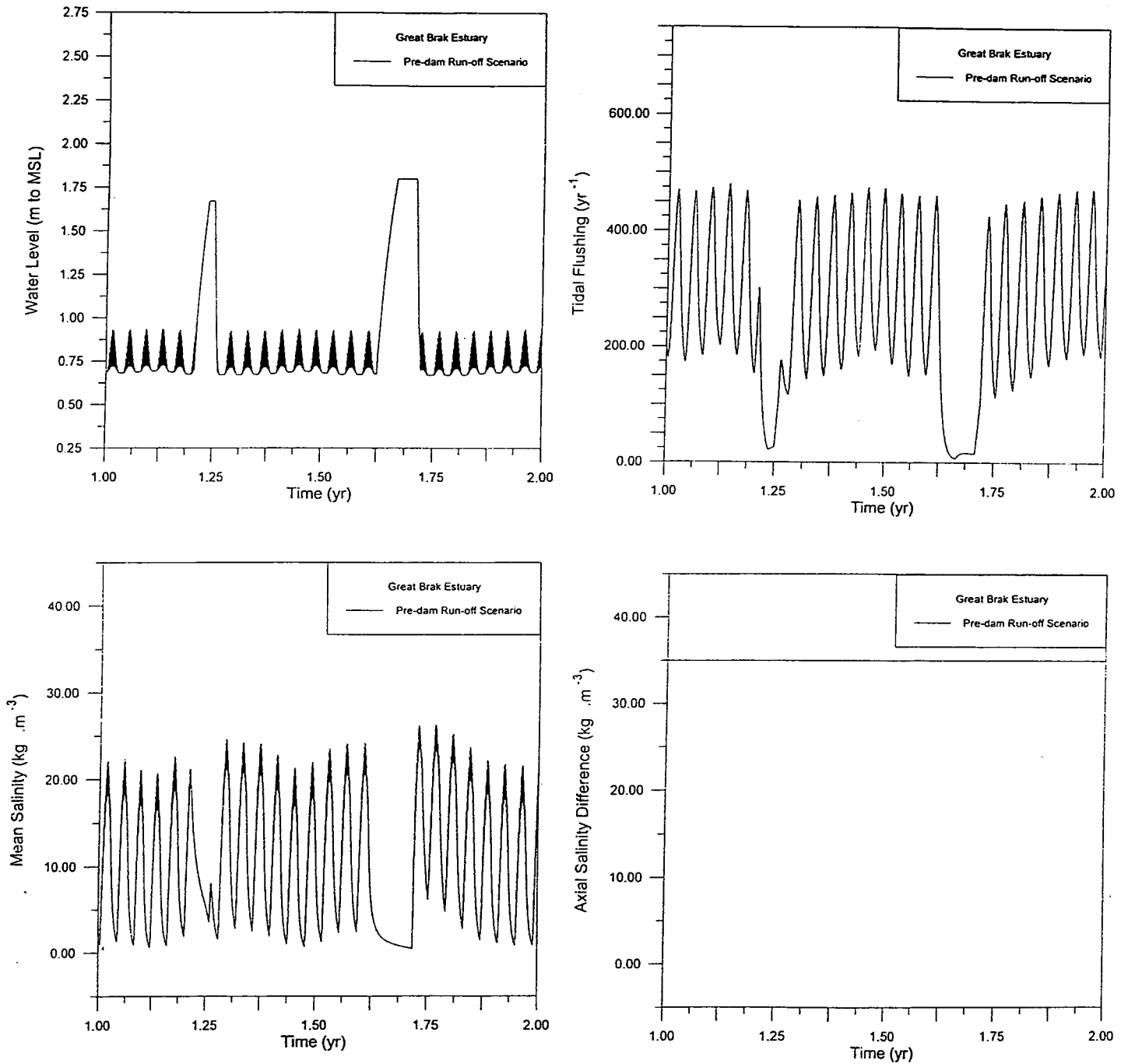

Figure 5.10 Water levels (top left), tidal flushing (top right), mean salinities (bottom left) and axial salinity differences (bottom right) simulated by the ESM over years 1 to 2 under the pre-dam run-off scenario.

should not be impeded for too long in the summer months. In winter, the higher waves make breaching of a mouth less likely to be successful and the ecological requirements for an open mouth are minimal. The mean salinities in the estuary are higher under this scenario than under natural conditions, with spring tidal maxima ranging from 21 ppt to 26 ppt and neap tidal minima from 7 ppt to about 2 ppt. A near zero minimum occurs when the mouth is closed during May/June. The axial salinity difference remains 35 ppt throughout, indicating that the upper reaches of the estuary maintain their brackish character under this scenario. The stratification-circulation state is partially mixed. Tidal fluxes and current speeds in the mouth area are very similar to the natural situation. However, the tidal flushing variable shows reduced maxima of 475 yr^{-1} compared with the natural situation and has two near zero minima owing to the two mouth closure events per annum.

3. *The post-dam run-off scenarios*

Water levels under the post-dam run-off scenarios are very similar to those under both the other run-off scenarios when the mouth is open. However, the mouth closes four times per year. When the mouth closes, the estuary gradually fills owing to the base flow entering the head of the estuary. Obviously the rate of increase in water level is greater under the post-dam run-off scenario with higher base flow than with low base flow. Thus, under scenario 3a, water levels of 1.62 m to MSL are achieved and the mouth is breached artificially (Figure 5.11). A longer period of mouth closure and high water levels is permitted in winter than in summer. However, under scenario 3b, in which it is assumed that the only base flow is that entering the estuary from the dam, water levels in excess of 1.35 m to MSL are not achieved (Figure 5.12). Mouth breaching is still undertaken as in scenario 3a to ensure that the mouth is open at least 40% of the year. Mean salinities in the estuary are considerably higher than under the natural or the pre-dam situations with spring tidal maxima of between 27 and 29 ppt exhibited under scenario 3a and neap tidal minima of between 12 and 5 ppt occurring. Under scenario 3b, the spring tidal maxima range between 32 and 33.5 ppt and the neap tidal minima between 29 and 24 ppt. When the mouth is closed, salinities decrease to between 7 and 2 ppt under scenario 3a and between 17.5 and 10 under scenario 3b. Clearly, the brackish component of the estuary is severely affected under the post-dam situation. Even under scenario 3a, there are indications of strong increases in the salinity of the estuary and reduced axial variation. The axial salinity differences bear this out, declining from 35 ppt for parts of the year. However, under scenario 3b, this effect on the estuary is shown to be dramatic with the axial salinity difference never achieving values greater than 20 ppt. Despite this, the estuary remains in a partially mixed state, but with far less variation in salinities. Tidal fluxes and current speeds at the mouth are similar to the natural and pre-dam conditions, but the tidal flushing variable exhibits considerable change. The maxima under scenarios 3a and 3b are only 450 and 430 yr^{-1} , respectively, while minima of zero occur during each mouth closure event.

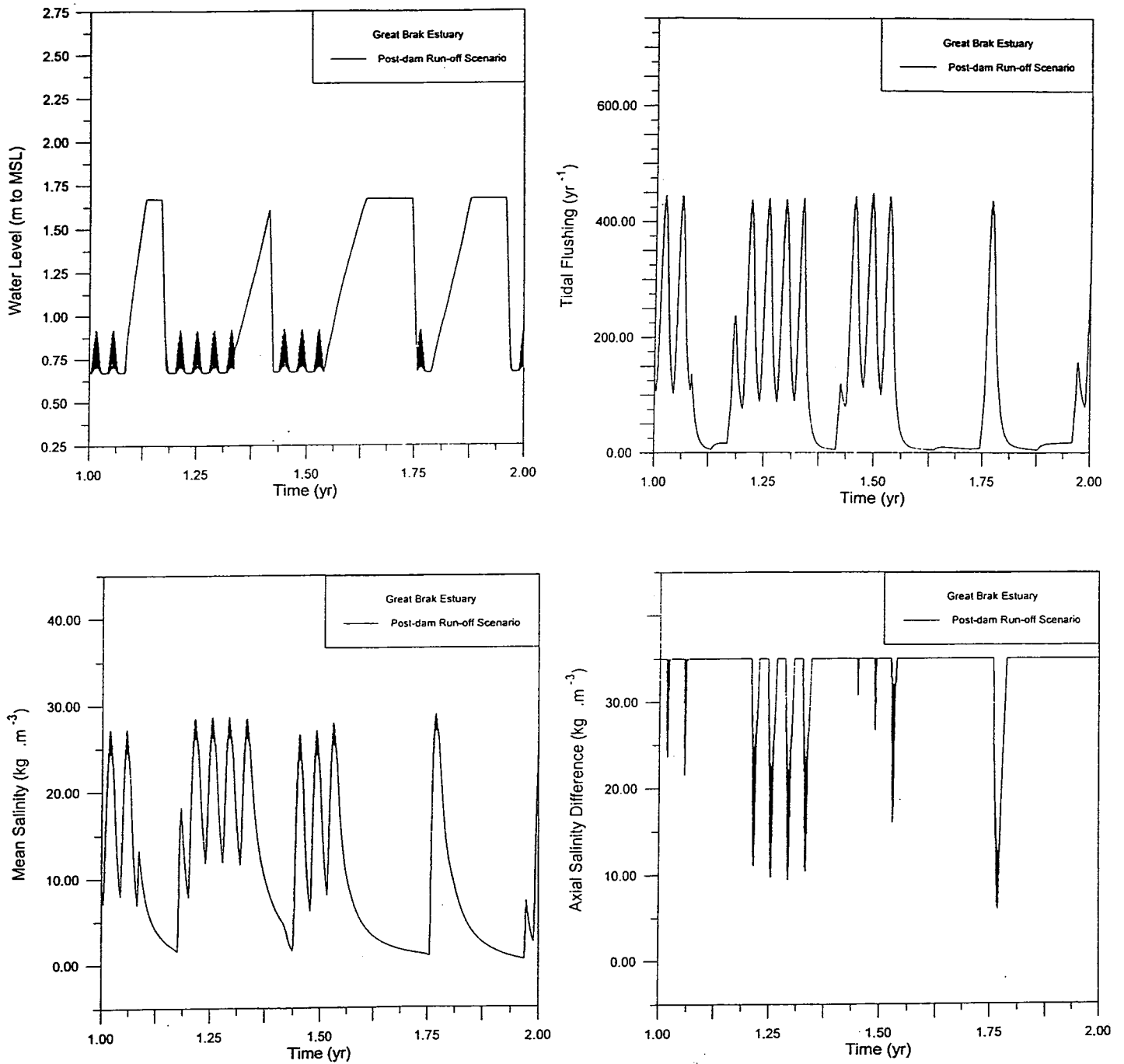

Figure 5.11 Water levels (top left), tidal flushing (top right), mean salinities (bottom left) and axial salinity differences (bottom right) simulated by the ESM over years 1 to 2 under the post-dam run-off scenario with high base flow.

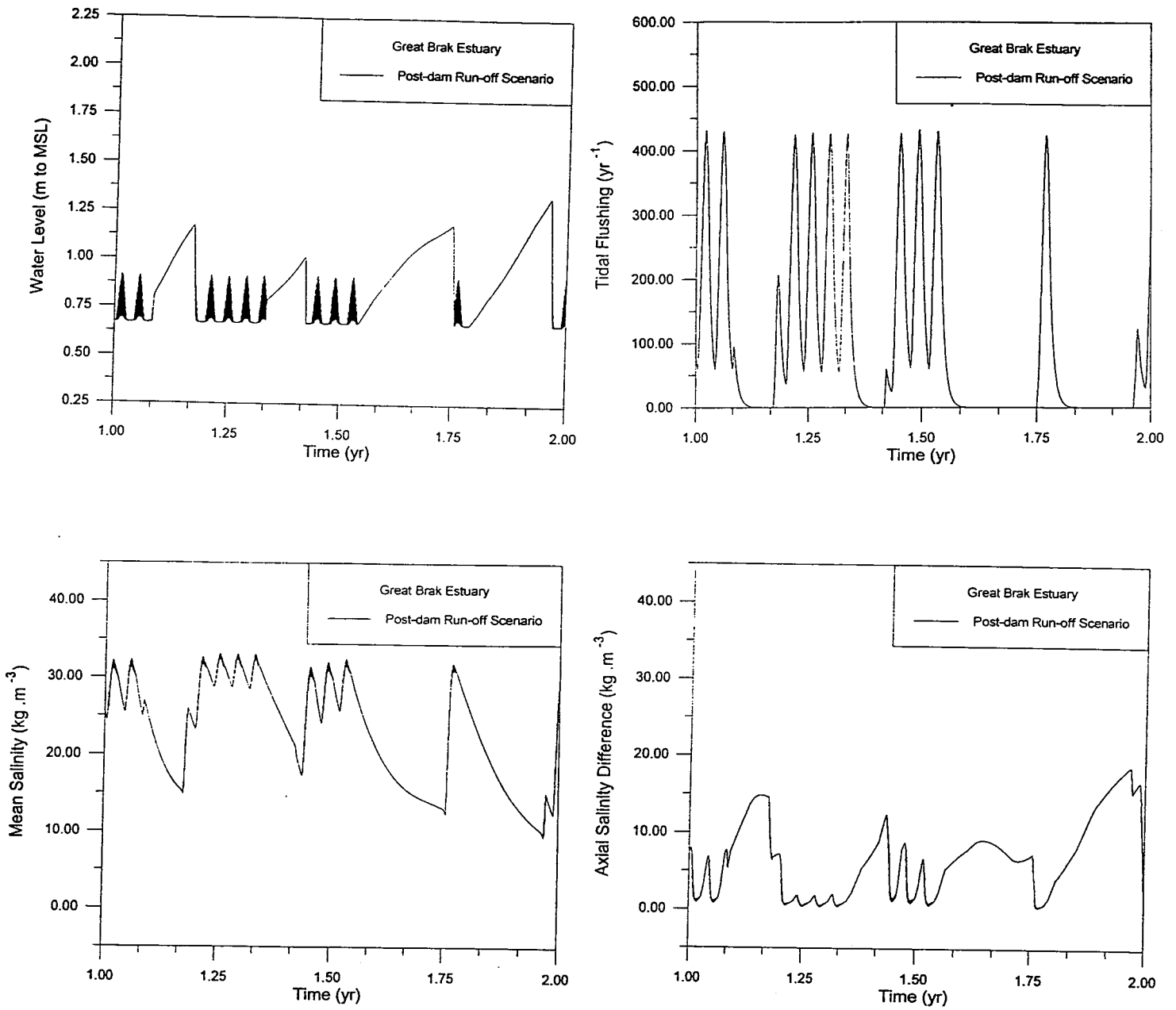

Figure 5.12 Water levels (top left), tidal flushing (top right), mean salinities (bottom left) and axial salinity differences (bottom right) simulated by the ESM over years 1 to 2 under the post-dam run-off scenario with low base flow.

Management performance indices

The effects of different run-off scenarios on an estuarine system may be summarised in management performance indices generated by the Estuarine Systems Model. In the case of the Great Brak estuary, the efficacy of flushing under scenario 2 (70% of natural MAR) is 84% of that under the natural scenario, while it is 38% and 34% under the post-dam scenarios 3a (29% of natural MAR) and 3b (6% of natural MAR), respectively. Thus the performance index for flushing provides an indication of the severity of the decline in the state of the physical environment owing to reduced freshwater flow.

Disturbance scenarios

A further indication of the effects of reduced freshwater flow may be obtained by applying disturbances to the steady dynamic states attained under the different run-off scenarios. The disturbances selected include: a dry situation of a 50% reduction in base flow for the period from mid-March to mid-June in the second year of the simulation, and a flood of volume equivalent to the 1 in 50 year event timed to occur in October of the second year of the simulation for each run-off scenario. In the case of the dry disturbance, which occurs when the mouth of the estuary is open (under all of the run-off scenarios), the mean salinities in the system increase and the axial salinity gradients decrease. Although the relative magnitude of the response is higher under the natural and pre-dam situations than under the post-dam scenarios, the effects are less severe because considerable base flow is still entering the system. However, in the post dam situation, such a reduction in base flow causes already high salinities to increase further and reduces low axial differences, exasperating a bad situation. The effects of the 1 in 50 year flood disturbances differ for each of the run-off scenarios, because the flood volumes and maximum discharge rates to the estuary differ. The maximum discharge rate for the natural run-off scenario flood disturbance is $820 \text{ m}^3 \cdot \text{s}^{-1}$, whereas for the pre-dam situation it is $800 \text{ m}^3 \cdot \text{s}^{-1}$ and for the post-dam situation it is $686 \text{ m}^3 \cdot \text{s}^{-1}$. In each case, the sill height at the mouth is scoured to a level approximately equal to MSL and water levels greater than 3 m to MSL are predicted. The intrusion of salinity into the estuary following the flood is more rapid under the post-dam run-off scenarios than under the pre-dam or natural scenarios. This is ascribed to differences in base flows. By December, the effects of the flood on the abiotic environment of the estuary have dissipated under all of the run-off scenarios.

Model Limitations and Range of Application

The Estuarine Systems Model is optimally applied to a small, intermittently closed estuary.. Thus the Great Brak Estuary is a good example of a system with management concerns for which the ESM can usefully simulate the responses of the physical environment to freshwater inflows. It is clear that the ESM underpins the predictive ability of the other estuarine models in this case study.

Results from the Estuarine Systems Model simulations are supplied to the ecological models (PEDSSys, DVM and EEEM) in the form of daily inflows, minimum and maximum water levels, average salinities, stratification index values, flushing rates, sill heights at the mouth, maximum current velocities through the mouth and tidal fluxes.

5.3.4 The Plant Estuarine Decision Support System

PEDSSys was used to predict the response of the plants to the different run-off scenarios. Physical data from a 28 day Mike 11 simulation and data from a two year simulation by the Estuarine System Model were used. Three run-off scenarios were considered, namely the natural, pre-dam and post-dam scenarios. Mike 11 was also used to simulate the effect of a flood release.

The form of the results provided by PEDSSys for the estuarine macrophytes is a growth rate adjustment score with a range of -10 to +10, where zero means that the plants are unaffected, a positive score means that the growth rate will increase, a negative score means that the growth rate will decrease and a score of -10 means that the plants will die.

The following estuarine macrophytes were considered in the Great Brak Case Study:

- submerged macrophytes (<0.89 m +MSL): *Zostera capensis* and *Ruppia cirrhosa*
- saltmarsh plants (0.89 - 1.22m +MSL): *Sarcocornia perennis* and *Sporobolus virginicus*
- emergent reed: *Phragmites australis*.

Two plants that are included here but were not considered in the Kromme case study are *Ruppia cirrhosa* and *Sporobolus virginicus*. *Ruppia* is a cosmopolitan genus that has been found in hypersaline ponds as well as freshwater ditches. *Ruppia cirrhosa* is sensitive to desiccation, but has a wide salinity tolerance range and can tolerate fluctuating salinity better than *Zostera capensis*. In South African estuaries *Ruppia* is common in temporarily closed brackish systems and *Zostera* is dominant in tidal marine estuaries, because of its stronger morphological structure and ability to survive daily periods of exposure (Adams and Bate 1994 a,b). It is, however, sensitive to flow velocities greater than 0.5 m s^{-1} .

Sporobolus virginicus, commonly known as brakgras, grows optimally at a salinity of less than 18 ppt. Tolerance to submergence depends on the salinity to which the plants are exposed. For example Breen *et al.* (1977) showed that *Sporobolus* grew when inundated at a salinity of 20 ppt for one month, but no growth occurred at a salinity of 30 ppt.

The response of the estuarine flora to different run-off scenarios as simulated by Mike 11

The physical environmental data provided by Mike 11 and used by PEDSSys included the average salinity for 28 days (Table 17) and the maximum flow velocity. The turbidity was assumed to be low and the water level variations were assumed to be very similar to those presently occurring in the estuary. For the flood release scenario it was assumed that the water level increased but was less than 2.5 m to MSL.

Table 17 Average salinity values at the five stations for the different scenarios

RUN-OFF SCENARIOS	STATIONS				
	R2	R4	R6	R8	R8
Natural run-off	17	11	8	2	0.5
Natural flood	25	15	9	2.5	0.5
Pre-dam	21	15	12	5	2
Pre-dam flood	28	20	16	6	3
Post-dam	32	32	31	30	28
Post-dam flood	33	31	29	26	25

Zostera capensis and *Ruppia cirrhosa*

Under the natural and pre-dam run-off scenarios *Zostera* would not be found in the upper reaches of the estuary (stations R8). Growth rate adjustment scores are negative (Table 18). The persistent low salinity in the upper reaches (Table 17) would suppress *Zostera* growth. However, optimal *Zostera* growth would occur under post-dam conditions. The maximum growth rate adjustment score of 10 was obtained for all sites except R2 (Table 18). In all cases station R2 has a lower growth rate adjustment score than the other sites because of higher current velocities. This applies for both *Ruppia* (Table 19) and *Zostera* (Table 18).

Growth rate adjustment scores for *Ruppia* do not differ for the different run-off scenarios (Table 19). *Ruppia* is an opportunistic species and is adapted to fluctuating environmental conditions. For example, it has a wide range of salinity tolerance (0-45ppt, Adams and Bate 1994a). The effect of the flood release was to reduce growth of both submerged macrophytes as the water level rises, reducing light intensity.

Table 18 The growth rate adjustment scores for the submerged macrophyte, *Zostera capensis*, at different stations.

RUN-OFF SCENARIOS	STATIONS				
	R2	R4	R6	R8	R8
Natural run-off	7	10	2.7	-4.4	-4.5
Natural flood	0.5	0.5	-7.8	-10	-10
Pre-dam	7	10	10	-4.5	-4.1
Pre-dam flood	0.5	0.5	0.5	-7.8	-10
Post-dam	7	10	10	10	10
Post-dam flood	0.5	0.5	0.5	0.5	0.5

Phragmites australis

High growth rate adjustment scores were obtained for both the natural and pre-dam run-off scenarios as *Phragmites* thrives under brackish conditions (Table 20). The higher salinities (30 ppt) for post-dam conditions were the cause of reduced growth. *Phragmites* would possibly only occur in the upper reaches at R8, whereas for the natural and pre-dam run-off scenarios, it would occur along the length of the estuary. The post-dam flood scenario shows that floods are important for *Phragmites*. The flood lowers salinities (Table 17) and the growth rate adjustment score increases from 0 to 3.3 for most stations (Table 20).

Table 19 The growth rate adjustment scores for the submerged macrophyte, *Ruppia cirrhosa*, at different stations.

RUN-OFF SCENARIOS	STATIONS				
	R2	R4	R6	R8	R8
Natural run-off	7	10	10	10	10
Natural flood	0.5	0.5	0.5	0.5	0.5
Pre-dam	7	10	10	10	10
Pre-dam flood	0.5	0.5	0.5	0.5	0.5
Post-dam	7	10	10	10	10
Post-dam flood	0.5	0.5	0.5	0.5	0.5

In all the above predictions it was assumed that the emergent plants would not be completely submerged. Although water levels would rise under flood conditions, water level data were not supplied by Mike 11. PEDSSys provides six options for changes in water level. Table 21 shows the effect of water level fluctuations on *Phragmites* for two different salinity conditions.

Although the predictions were made for the month of November (spring), submergence affects the plants differently depending on the season. In spring, new plants and shoots are establishing and submergence inhibits growth. In summer, if the plants were shorter than 1 m, then extension growth would be stimulated. However, prolonged submergence (> 30 days) would inhibit growth as leaves cannot photosynthesise underwater. Submergence during autumn would have a negative effect on plants as this is when nutrients are remobilised for spring growth. Winter submergence is less severe than for the other seasons as this is when the plants die back naturally. Table 21 shows that as the water increased from covering 25 % of the above-ground plant material to > 75%, plant growth was reduced accordingly.

Submergence tolerance also depends on the salinity to which the plants are exposed. The growth rate adjustment scores for *Phragmites* are lower when covered with saline (26 ppt) water than when covered with fresher (6 ppt) water (Table 21).

Although emergent plants are sensitive to submergence, they do require waterlogged conditions. PEDSSys showed that the worst case scenario for *Phragmites* is if the water level decreases and the sediment dries out. The results showed a predicted growth rate adjustment score of -6.7 (Table 21).

Table 20 The growth rate adjustment scores for the emergent reed, *Phragmites australis*, at different stations.

SCENARIOS	STATIONS				
	R2	R4	R6	R8	R8
Natural run-off	10	10	10	10	10
Natural flood	3.3	10	10	10	10
Pre-dam	10	10	10	10	10
Pre-dam flood	3.3	3.3	10	10	10
Post-dam	0	0	0	0	3.3
Post-dam flood	0	3.3	3.3	3.3	3.3

Table 21 The effect of water level fluctuations on the growth rate adjustment score of *Phragmites australis* for two scenarios. (1. Pre-dam flood, Station R8, 6ppt; 2. Post-dam flood, Station R8, 26 ppt).

CHANGE IN WATER LEVEL	1	2
risen to cover > 75 % of plant	2.5	-4.2
risen to cover 50-75 % of plant	3.1	-3.5
risen to cover 25-50 % of plant	3.7	-3.0
risen to cover < 25 % of plant	6.3	-0.4
dropped, sediment remains saturated	10	3.3
dropped, sediment dries out	-6.7	-6.7

Sporobolus virginicus and *Sarcocornia perennis*

Growth rate adjustment scores for these saltmarsh macrophytes (Tables 22 & 23) were similar for the natural and pre-dam run-off scenarios, but were lower for the post-dam scenario. The flood release in the post dam condition did not reduce salinity to the extent that this had a beneficial effect on the plants. Substantial fluctuations in salinity occurred at stations R2 and R4 for the flood release scenario. This caused the lower growth rate adjustment scores compared with the other sites in the estuary. For the natural and pre-dam run-off scenarios, *Sporobolus* and *Sarcocornia* would be expected to occur along the length of the estuary.

Table 22 The growth rate adjustment scores for the saltmarsh macrophyte, *Sporobolus virginicus*, at different stations.

RUN-OFF SCENARIOS	STATIONS				
	R2	R4	R6	R8	R8
Natural run-off	10	10	10	10	10
Natural flood	3.3	3.3	10	10	10
Pre-dam	3.3	10	10	10	10
Pre-dam flood	3.3	3.3	10	10	10
Post-dam	3.3	3.3	3.3	3.3	3.3
Post-dam flood	3.3	3.3	3.3	3.3	3.3

Table 23 The growth rate adjustment scores for the saltmarsh macrophyte, *Sarcocornia perennis*, at different stations.

RUN-OFF SCENARIOS	STATIONS				
	R2	R4	R6	R8	R8
Natural run-off	10	10	10	10	10
Natural flood	10	10	10	10	10
Pre-dam	10	10	10	10	10
Pre-dam flood	10	10	10	10	10
Post-dam	3.3	3.3	3.3	10	10
Post-dam flood	3.3	3.3	10	10	10

Mike-11 provided physical data that allowed predictions to be made on the response of plants in different positions along the length of the estuary. The effect of different freshwater input scenarios on the distribution of plants up the length of the estuary could therefore be assessed. For both the natural and pre-dam run-off scenarios there was a salinity gradient up the length of the estuary. Different macrophytes were distributed along this gradient because of their different salinity tolerances. *Zostera capensis* flourished in the lower reaches (Table 18, station R2 to R6) whereas the emergent reed *Phragmites* flourished in the middle and upper reaches (Table 20, station R4 to R8). For all scenarios PEDSSys predicted that *Ruppia* would occur throughout the estuary, indicating the opportunistic nature of this plant.

Under the post-dam run-off conditions the salinity gradient decreased and this caused a reduction in the diversity of plant species. PEDSSys predicted optimal *Zostera* growth under post-dam conditions. *Zostera* would extend into the upper reaches and the brackish community, of which *Phragmites* is an indicator, would be absent. The scenario approach indicated that large dams can have a significant effect on the physical conditions of an estuary and this in turn alters the biology of the system. Freshwater needs to be released from dams in order to establish salinity gradients in estuaries, especially if these were a feature of natural conditions.

There was greater physical variability for the natural and pre-dam run-off scenarios and consequently growth rate adjustment scores for *Zostera* differed for different stations. Construction of the dam reduced this variability, a result of this was the similar performance of *Zostera* at different stations for post-dam conditions (Table 18).

Floods are important for plants in the post-dam run-off scenario. Growth rate adjustment scores for *Phragmites* were higher where the post-dam flood scenario was applied than for the scenario where no flood occurred.

The response of the estuarine flora to different run-off scenarios as simulated by the ESM

The ESM provided physical data for four different scenarios; natural run-off, pre-dam, post-dam with high base flow and post-dam with low base flow. Disturbance scenarios were also considered; i.e. flood conditions, where a 1 in 50 year flood occurred in October of the second year, and dry conditions which caused a 50 % reduction in base flow during the month of April. The ESM provided physical data for a two year period and PEDSSys predictions were made using data for the second year.

Physical data provided by the ESM were used to compare the effect of closed and open mouth conditions on the plants for the different scenarios. Intertidal saltmarshes occur between 0.89 to 1.22 m to MSL and submerged macrophytes at < 0.89 m to MSL. During closed mouth conditions the water level rises, sometimes flooding both the intertidal and supratidal marsh plants.

1. *The natural run-off scenario*

Plants responded similarly to closed mouth conditions for all scenarios (Table 24). Water levels and salinity were similar for the steady state and disturbance scenarios. Water levels rose to a maximum of 1.9 m to MSL, flooding the marsh areas. Approximately 25-50 % of the above-ground parts of marsh plants would be inundated. Growth rate adjustment scores for the emergent macrophytes (*Sarcocornia*, *Sporobolus* and *Phragmites*) were low but positive (Table 24). The only negative score was for the grass *Sporobolus virginicus* (Table 24b). *Sporobolus* flowers in spring and inundation at this time would inhibit flowering.

For the submerged macrophytes, *Zostera* and *Ruppia*, water levels would rise but would be less than 2.5 m. The increase in water level and the resultant increase in turbidity probably accounts for the negative growth rate adjustment scores for these plants (Table 24). *Ruppia* had higher scores than *Zostera* as it tolerates the low salinities (1-5 ppt) found under closed mouth conditions better than *Zostera*.

For all the run-off the flood disturbance scenarios, open mouth conditions are optimal for plant growth. When the mouth was open, all plants considered by PEDSSys obtained the maximum growth rate adjustment score of 10. The emergent plants would not be inundated but the sediment would remain saturated. *Ruppia* and *Zostera* would remain submerged.

Table 24 Physical conditions and plant growth rate adjustment scores for closed and open mouth conditions under the natural run-off scenario

A. STEADY DYNAMIC STATE

Mouth condition	Closed	Open
Time (days)	17	300
Salinity	2	11
Current speed (m s ⁻¹)	0	1
Max. water level (m)	1.9	0.9
<i>Zostera capensis</i>	-10	10
<i>Ruppia cirrhosa</i>	0	10
<i>Sarcocornia perennis</i>	2.2	10
<i>Sporobolus virginicus</i>	2.2	10
<i>Phragmites australis</i>	2.2	10

B. FLOOD DISTURBANCE

Mouth condition	Closed		Open
	Winter	Spring	
Season			
Time (days)	18	14	330
Salinity	5	1	15
Current speed (m s ⁻¹)	0	0	1.2
Max. water level (m)	1.9	1.9	0.8
<i>Zostera</i>	-10	-9.2	10
<i>Ruppia</i>	-0.5	-2.5	10
<i>Sarcocornia</i>	1.2	0.7	10
<i>Sporobolus</i>	1.2	-1.6	10
<i>Phragmites</i>	1.2	0.7	10

C. DRY DISTURBANCE

Mouth condition	Closed		Open
	Winter	Spring	
Season			
Time (days)	16	28	300
Salinity	1	2	24
Current speed (m s ⁻¹)	0	0	1.2
Max. water level (m)	1.6	1.8	0.6
<i>Zostera</i>	-9.8	-10	-10
<i>Ruppia</i>	-1.5	0.5	-10
<i>Sarcocornia</i>	0.2	0.7	-3.3
<i>Sporobolus</i>	0.2	2.9	-10
<i>Phragmites</i>	0.2	0.7	-10

Open mouth conditions under the dry disturbance scenario is the worst case scenario for all plants (Table 24). Water levels are low (0.6 m) and it is assumed that the submerged plants are exposed and the sediment associated with the emergent plants is drying out. This would have a severe effect on plant growth. All plants except *Sarcocornia* obtained the lowest growth rate adjustment score of -10. PEDSSys predicted a score of -3.3 for *Sarcocornia*, because this plant can tolerate dry sediment conditions better than the other plants.

2. *The pre-dam run-off scenario*

Under the pre-dam run-off scenario, the mouth closed twice under the dynamic steady state conditions (Table 25a), whereas it only closed once under natural run-off conditions (Table 24a). For the dry disturbance pre-dam scenario the mouth closed 4 times (Table 25c). Emergent plants are sensitive to the duration of mouth closure. Growth rate adjustment scores were lower for autumn when the mouth was closed for 72 days than in winter when the mouth closed for 60 days (Table 25c).

Under the flood disturbance scenario, growth rate adjustment scores for the emergent plants were lower in summer than in winter. This can be attributed to the higher summer salinity (Table 25b), because submergence tolerance depends on the salinity to which the emergent plants are exposed.

The PEDSSys predictions indicate that the open mouth conditions are better for both marsh plants and submerged macrophytes than closed mouth conditions, provided water levels are such that the submerged macrophytes are not exposed and the sediments of the emergent macrophytes remain saturated. These conditions apply to both the steady state (Table 25a) and flood disturbance scenarios (Table 25b).

If water levels are low during open mouth conditions (< 0.7 m) then dry conditions have a severe effect on the plants (Table 25c). The plants respond as they did for the natural run-off dry disturbance scenario (Table 24c).

3a *Post-dam run-off scenario with high base flow*

Post-dam conditions caused the mouth to close 4 times during the year for both the steady state and disturbance scenarios. Under the steady state and flood disturbance conditions, when the mouth was open, salinities were higher than for natural and pre-dam run-off scenarios. This decreased the vigour of species that prefer brackish conditions (eg. *Sporobolus* and *Phragmites*). Growth rate adjustment scores for these plants were 0 compared to 10 for *Sarcocornia* which is more salt tolerant (Table 26a & b). For the flood disturbance scenario salinity is lower than for the dynamic steady state (19 ppt compared with 25 ppt). This does not improve the growth of *Sporobolus* or *Phragmites* as both plants grow optimally at a salinity of 15 ppt.

Table 25 Physical conditions and plant growth rate adjustment scores for closed and open mouth conditions under the pre-dam run-off scenario.

A. STEADY DYNAMIC STATE

Mouth condition	Closed		Open
	Summer	Winter	
Season			
Time (days)	23	30	300
Salinity	5	0	15
Current speed (m s ⁻¹)	0	0	0.8
Max. water level (m)	1.7	1.8	0.9
<i>Zostera capensis</i>	-10	-10	10
<i>Ruppia cirrhosa</i>	0	0	10
<i>Sarcocornia perennis</i>	2.2	2.2	10
<i>Sporobolus virginicus</i>	2.2	2.2	10
<i>Phragmites australis</i>	2.2	2.2	10
<i>Juncus kraussii</i>	2.2	2.2	10

B. FLOOD DISTURBANCE

Mouth condition	Closed		Open
	Summer	Winter	
Season			
Time (days)	14	17	300
Salinity	6	3	14
Current speed (m s ⁻¹)	0	0	0.7
Max. water level (m)	1.5	1.3	0.8
<i>Zostera</i>	-6.1	-10	10
<i>Ruppia</i>	-2.5	-1	10
<i>Sarcocornia</i>	-0.8	0.7	10
<i>Sporobolus</i>	-0.8	0.7	10
<i>Phragmites</i>	-0.8	0.7	10

C. DRY DISTURBANCE

Mouth condition	Season	Closed				Open
		Spr.	Sum.	Aut.	Win.	
Time (days)		30	25	72	60	
Salinity		1	5	2	1	27
Current speed (m s ⁻¹)		0	0	0	0	1.2
Max. water level (m)		1.7	1.6	1.4	1.7	0.7
<i>Zostera</i>		-10	-10	-10	-10	-10
<i>Ruppia</i>		0.5	0.5	0.5	0.5	-10
<i>Sarcocornia</i>		3.7	2.2	-4.8	-2.5	-3.3
<i>Sporobolus</i>		1.4	2.2	-2.5	-2.5	-10
<i>Phragmites</i>		3.7	2.2	-4.8	-2.5	-10

Table 26 Physical conditions and plant growth rate adjustment scores for closed and open mouth conditions under the post-dam run-off scenario with high base flow

A. STEADY DYNAMIC STATE

Mouth condition	Closed				Open
	Season	Sum.	Aut.	Win.	
Time (days)	30	32	77	50	150
Salinity	2	2	1	1	25
Current speed (m s ⁻¹)	0	0	0	0	0.8
Max. water level (m)	1.6	1.6	1.6	1.6	0.9
<i>Zostera capensis</i>	-10	-10	-10	-10	10
<i>Ruppia cirrhosa</i>	0	0	0	0	10
<i>Sarcocornia perennis</i>	3.7	1.7	-4.8	-2.5	10
<i>Sporobolus virginicus</i>	1.4	1.7	-4.8	-2.5	0
<i>Phragmites australis</i>	3.7	1.7	-4.8	-2.5	0

B. FLOOD DISTURBANCE

Mouth condition	Closed				Open
	Season	Sum.	Aut.	Win.	
Time (days)	27	26	74	65	150
Salinity	4	6	3	3	19
Current speed (m s ⁻¹)	0	0	0	0	1.2
Max. water level (m)	1.7	1.7	1.7	1.7	0.9
<i>Zostera</i>	-8.2	-7.4	-10	-10	10
<i>Ruppia</i>	0.5	0.5	0.5	0.5	10
<i>Sarcocornia</i>	2.9	2.2	-4.8	-2.5	10
<i>Sporobolus</i>	0.7	2.2	-2.5	-2.5	0
<i>Phragmites</i>	2.9	2.2	-4.8	-2.5	0

C. DRY DISTURBANCE

Mouth condition	Closed				Open
	Season	Sum.	Aut.	Win.	
Time (days)	33	27	79	62	150
Salinity	8	15	14	5	30
Current speed (m s ⁻¹)	0	0	0	0	1.2
Max. water level (m)	0.9	0.9	0.9	1	0.7
<i>Zostera</i>	-8.2	0.5	0.5	-10	-10
<i>Ruppia</i>	0.5	0.5	0.5	0.5	-10
<i>Sarcocornia</i>	5.8	6.7	0	0	-3.3
<i>Sporobolus</i>	5.8	6.7	0	0	-10
<i>Phragmites</i>	5.8	6.7	0	0	-10

Compared with the other scenarios, water levels are lower for the dry disturbance condition when the mouth is closed. Less than 25 % of the above-ground portion of emergent plants would be inundated. This has a beneficial effect on the plants (Table 26c). Growth rate adjustment scores were higher for the dry disturbance scenario than for the flood disturbance and steady state conditions.

Under the dry disturbance scenario with open mouth conditions, the plants responded as they did for the natural and pre-dam run-off scenarios (Table 26c).

3b *Post-dam run-off scenario with low base flow*

When the mouth was closed water levels were lower than for the post-dam run-off scenario with high base flow. It is assumed that less than 25 % of the emergent plants would be covered with water and in the case of submerged macrophytes, water levels would not exceed 2.5 m. As a result of these conditions growth rate adjustment scores are higher for this scenario with low base flow than for the post-dam scenario with high base flow (Table 27).

Growth rate adjustment scores for *Zostera capensis* were negative for the flood disturbance scenario (Table 27b). This can be related to the lower salinity conditions for this scenario compared with the steady dynamic state (Table 27a) and dry disturbance scenarios (Table 27c).

The plants responded to open mouth conditions as they did for the post-dam run-off scenario with high base flow.

Summary of PEDSSys Findings

Thus the physical data provided by Mike 11 was effectively used by PEDSSys to predict the distribution of macrophytes along the length of the estuary, whereas the information provided by the ESM was useful in predicting the effect of mouth condition on the plants.

PEDSSys showed that closed mouth conditions were more detrimental to marsh plants than open mouth conditions, that is if the water level is > 0.9 m to MSL and the emergent plants are covered. Prolonged inundation during the growing season is harmful to most marsh plants. Closed mouth conditions also proved to be detrimental to *Zostera*, as a result of the high water levels and increased turbidity.

Open mouth conditions for the dry disturbance scenario represent the worst case scenario for the plants. Water levels are less than 0.7 m to MSL. The submerged plants would be exposed and the marsh sediments would dry out. All plants except *Sarcocornia* obtained the lowest possible

Table 27 Physical conditions and plant growth rate adjustment scores for closed and open mouth conditions under the post-dam run-off scenario with low base flow

A. STEADY DYNAMIC STATE

Mouth condition	Season	Closed			Open	
		Spr.	Sum.	Aut.		Win.
Time (days)		33	30	77	77	150
Salinity		15	16	13	13	30
Current speed (m s ⁻¹)		0	0	0	0	0.8
Max. water level (m)		1	0.8	0.8	1	0.9
<i>Zostera capensis</i>		0	0	0	0	10
<i>Ruppia cirrhosa</i>		0	0	0	0	10
<i>Sarcocornia perennis</i>		5.8	6.7	0	0	10
<i>Sporobolus virginicus</i>		5.8	6.7	0	0	0
<i>Phragmites australis</i>		5.8	0	0	0	0

B. FLOOD DISTURBANCE

Mouth condition	Season	Closed			Open	
		Spr.	Sum.	Aut.		Win.
Time (days)		29	29	77	67	150
Salinity		9	10	9	5	25-30
Current speed (m s ⁻¹)		0	0	0	0	1.2
Max. water level (m)		1	0.8	0.9	1	0.7
<i>Zostera capensis</i>		-7.7	0.5	-10	-10	10
<i>Ruppia cirrhosa</i>		0.5	0.5	0.5	0.5	10
<i>Sarcocornia perennis</i>		6.3	6.7	0	0	10
<i>Sporobolus virginicus</i>		6.3	6.7	0	0	0
<i>Phragmites australis</i>		6.3	6.7	0	0	0

C. DRY DISTURBANCE

Mouth condition	Season	Closed			Open	
		Spr.	Sum.	Aut.		Win.
Time (days)		33	27	79	62	150
Salinity		8	15	14	5	30
Current speed (m s ⁻¹)		0	0	0	0	1.2
Max. water level (m)		0.9	0.9	0.9	1	0.7
<i>Zostera capensis</i>		2.3	10	10	10	-10
<i>Ruppia cirrhosa</i>		10	10	10	10	-10
<i>Sarcocornia perennis</i>		5.8	10	10	10	-3.3
<i>Sporobolus virginicus</i>		5.8	10	10	10	-10
<i>Phragmites australis</i>		5.8	10	10	-4	-10

growth rate adjustment score of -10. PEDSSys predicted a score of -3.3 for *Sarcocornia*, indicating that it could tolerate dry sediment conditions better than the other plants.

For the natural and pre-dam run-off scenarios, plants responded similarly to open mouth conditions. The maximum growth rate adjustment score of 10 was obtained for all plants for both the steady state and flood disturbance conditions. Although high water levels occurred under the flood disturbances these were not of sufficient duration to cause extensive die-back. Open mouth conditions are important for tidal flushing, essential to the functioning of intertidal saltmarshes. For the post-dam run-off scenarios, salinities for open mouth conditions were higher than those for other scenarios. According to the PEDSSys predictions a consequence of this would be reduced vigour of brackish species such as *Sporobolus* and *Phragmites*.

Apart from the natural run-off scenario, the mouth of the estuary closed four times under the dry disturbance. The PEDSSys predictions showed that emergent plants are sensitive to the duration of mouth closure. PEDSSys cannot be used to assess the effect of repetitive opening and closure of the mouth on the plants. However, this information can be provided by the dynamic vegetation model.

For the post-dam run-off scenarios without base flow, during closed mouth conditions water levels were lower than for other scenarios. The assumption made was that < 25 % of emergent plants would be inundated, consequently plant growth rate adjustment scores increased.

In conclusion, prolonged closure of the mouth has a negative effect on both saltmarsh plants and submerged macrophytes. However, the worst case scenario is dry conditions when the water level is low. Submerged macrophytes would be exposed and would die-back. Also, the emergent marsh plants cannot survive prolonged dry conditions. Optimal growth conditions would occur for the natural and pre-dam run-off scenarios when the mouth was open.

5.3.5 The Dynamic Vegetation Model

The aim of the vegetation modelling project was to develop spatial dynamic biomass growth models for selected estuarine macrophytes. This would serve to establish whether the available data was suitable for predictive modelling and assist in determining development requirements for the improvement of predictions in this field of estuarine management.

Zostera capensis, *Ruppia cirrhosa* and *Phragmites australis* were selected for inclusion in the model for the Great Brak case study. *Zostera* is a submerged macrophyte that is rooted in lower intertidal and subtidal substrata. It is common in permanently open, marine dominated estuaries. *Ruppia* is a submerged macrophyte that grows in temporarily open estuaries. It has a wider range of salinity tolerance than *Zostera* but cannot survive in estuaries with strong current velocities. *Phragmites* is an emergent macrophyte that is found in the upper brackish reaches.

The model equations and parameters are given in the appendix.

Model Results

The values assigned to the parameters were: sgr=specific growth rate in $\text{g.g}^{-1}.\text{day}^{-1}$; sdr=specific death rate in $\text{g.g}^{-1}.\text{day}^{-1}$. *Zostera*: sgr=0.005; sdr=0.005; *Ruppia*: sgr=0.005; sdr=0.005; *Phragmites*: sgr=0.05;sdr=0.05. (Note that because *Phragmites* has a higher sgr and sdr than *Zostera* and *Ruppia*, it's yearly equilibrium productivity (i.e. growth and reproductive success) is remarkably higher than *Zostera* and *Ruppia*.)

Simulation Approach

Growth and mortality are calculated with time steps of one day. Simulations are designed to estimate the theoretical equilibrium biomass of vegetation under the given environmental conditions. This is done by simulating vegetation development at a site over a number of years until the year-to-year change in model biomass becomes less than 1%. Simulations have been performed to investigate the effect of flood and dry disturbances on year-to-year vegetation dynamics. In this way resilience, resistance, and recovery from disturbances can be measured.

Model simulations for Mike 11 run-off scenarios 1,2 and 3

The results are presented in Tables 28 and 29. The first entry in Table 28 means that at station 1, over the area that has been modelled, *Zostera* occupies 0.3 of the space, *Ruppia* 0.13 of the space and *Phragmites* 0.26. This gives a total density of 0.69 of occupied space. Table 29 is read in a similar way.

No significant differences occur between scenarios 1 and 2. Scenario 1 is the natural run-off scenario and scenario 2 is the pre-dam run-off scenario. Under both inflow conditions a strong longitudinal salinity gradient is maintained and so there is no *Zostera* in the upper reaches. *Ruppia* appears at all the stations because of its wide range of salinity tolerance. The presence of *Phragmites* at the mouth of the estuary under the natural run-off scenario is due to low salinities.

Table 28 Equilibrium biomass density (g.m^{-2}) under the run-off scenarios 1,2 and 3, for 5 positions in the Great Brak Estuary (*Zostera/Ruppia/Phragmites*)

Scenario	Station 1	Station 2	Sation 3	Station 4	Station 5
1	0.3/0.13/0.26	0/ 0.27/ 0.42	0/ 0.25/ 0.68	0/ 0.25/ 0.68	0/ 0.25/ 0.68
2	0.31/ 0.12/ 0	0.19/ 0.16/ 0.31	0/ 0.27/ 0.68	0/ 0.26/ 0.68	0/ 0.26/ 0.68
3	0.31/ 0.12/ 0	0.31/ 0.12/ 0	0.31/ 0.13/ 0	0.36/ 0.16/ 0	0.36/ 0.17/ 0

Table 29 Total average yearly productivity (g.yr^{-1}) under the run-off scenarios 1,2 and 3, for 5 positions in the Great Brak Estuary (*Zostera/Ruppia/Phragmites*)

Scenario	Station 1	Station 2	Station 3	Station 4	Station 5
1	7.2/ 2.52/ 90	0/ 5/ 122	0/ 3.6/ 223	0/ 3.6/ 223	0/ 3.6/ 223
2	6/ 2.3/ 1	3.5/ 3/ 104	0.04/ 5.2/ 117	0/ 4.8/ 222	0/ 4.8/ 222
3	6/ 2.3/ 0	8.3/ 2.4/ 0	6/ 2.4/ 0	6.9/ 2.7/ 0	6.9/ 2.9/ 0

Under the post dam run-off scenario, a longitudinal salinity gradient is not maintained owing to reduced fresh water inflow, and *Zostera* begins to encroach up the estuary and displace *Phragmites*.

Figure 5.13 shows how the distribution of the macrophytes along the length of the estuary is affected by reduced fresh water inflow.

Model simulations for ESM run-off scenarios 1, 2, 3a and 3b

The ESM simulation results are given for one position on the estuary (near the middle reaches). The results are presented in Tables 30 and 31.

Under scenarios 1 (natural) and 2 (pre-dam) there is no *Zostera* present in the middle reaches of the estuary. This is from low salinities in the middle reaches that are created by the longitudinal salinity gradient. *Ruppia* is present in all scenarios because it has a wide salinity tolerance range.

Table 30 Equilibrium biomass density ($\text{g}\cdot\text{m}^{-2}$) under the run-off scenarios 1,2 3a and 3b (*Zostera/Ruppia/Phragmites*)

Scenario	1	2	3a	3b
Biomass density	0/ 0.27/ 0.43	0/ 0.29/ 0.36	0/0.42/ 0.23	0.19/0.16/ 0

Table 31 Total average yearly productivity ($\text{g}\cdot\text{m}^{-2}$) under the run-off scenarios 1,2, 3a and 3b (*Zostera/Ruppia/Phragmites*)

Scenario	1	2	3a	3b
Productivity	0/ 5/ 121	0/ 5/ 112	0.001/11/ 94	4.4/ 3.5/ 0

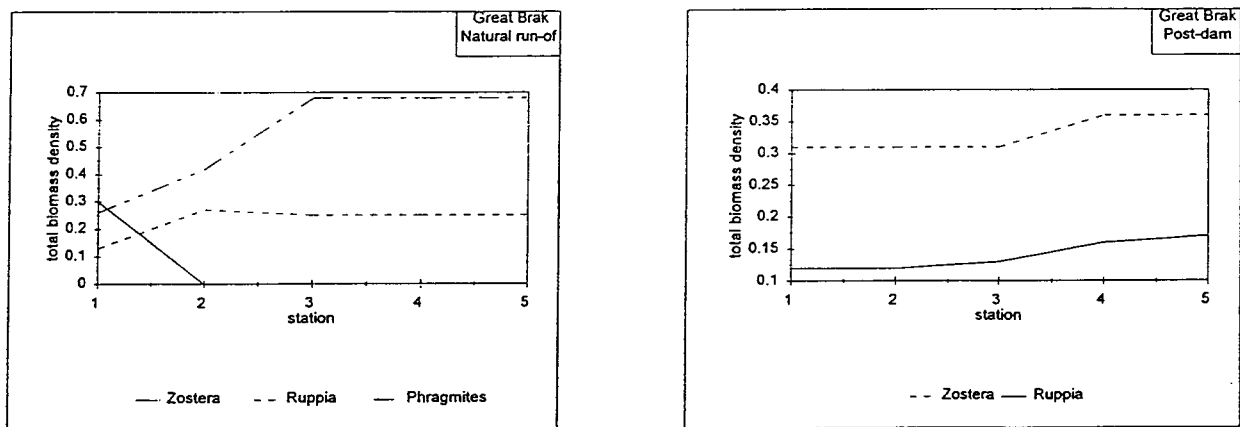

Figure 5.13 The effect of reduced freshwater inflows on the distribution of estuarine macrophytes. Under the natural run-off scenario (left), the longitudinal salinity gradient means that the salt tolerant *Zostera* occurs at the mouth, the brackish species *Phragmites* in the upper reaches and *Ruppia* throughout. Under the post-dam scenario (right), the natural distribution of macrophytes is lost and *Zostera* has encroached upstream displacing *Phragmites* communities.

In the post-dam run-off scenarios (3a - base flow from the catchment, and 3b - very little base flow from the catchment), *Zostera* has encroached into the middle reaches due to high salinities caused by reduced fresh water inflow. *Phragmites* is able to survive under scenario 3a because the strong base flow flushes out very high salinities. There is less *Phragmites* in scenario 2 than scenario 1 because of the higher salinities present in scenario 2.

Model simulations for ESM disturbance scenarios

The flood and dry disturbance scenarios were applied to the model. The amplitude of disturbance and the recovery time are given in Table 32.

Table 32 The recovery time (years) and amplitude (percentage) of disturbance of *Zostera* biomass for the ESM flood and dry disturbance scenarios. A negative amplitude means that there is a decrease in biomass after the disturbance.

Scenario	Recovery Time (years)		Amplitude	
	Flood	Dry	Flood	Dry
1	6	1	-75	-7
2	6	1	-72	-5
3a	3	1	-54	-7.6
3b	5	1	-38	-1

Figures 5.14 and 5.15 show the effects of the flood and dry disturbance scenarios, respectively. For the flood disturbance, the sudden decrease in biomass density in the natural and pre-dam run-off scenarios is due to the onset of the flood at the beginning of the second year. The effect of the flood on the post dam run-off scenario is not as marked because the presence of the dam reduces the amplitude of the flood. However, in all cases a severe impact on *Phragmites* is predicted because it is fully submerged during the flood disturbances. In reality, the *Phragmites* would not die back as rapidly as predicted. This feature needs to be refined in the DVM to ensure more realistic prediction of the response of the reeds. In contrast, the dry disturbance scenarios do not cause as substantial a change in biomass density, because water levels and salinity values do not change significantly. The increase in the biomass of *Phragmites* over days 31 to 180 in the dry natural and pre-dam scenarios, is due to a decrease in salinity, whereas the decrease from days 181 to 270 is ascribable to the dry disturbance.

The results from the vegetation model for the different scenarios show that the middle reaches of the Great Brak Estuary are dominated by brackish species under natural freshwater inflow. Since the construction of dams, stable sediment and salinity conditions have led to an encroachment of marine species in the middle reaches.

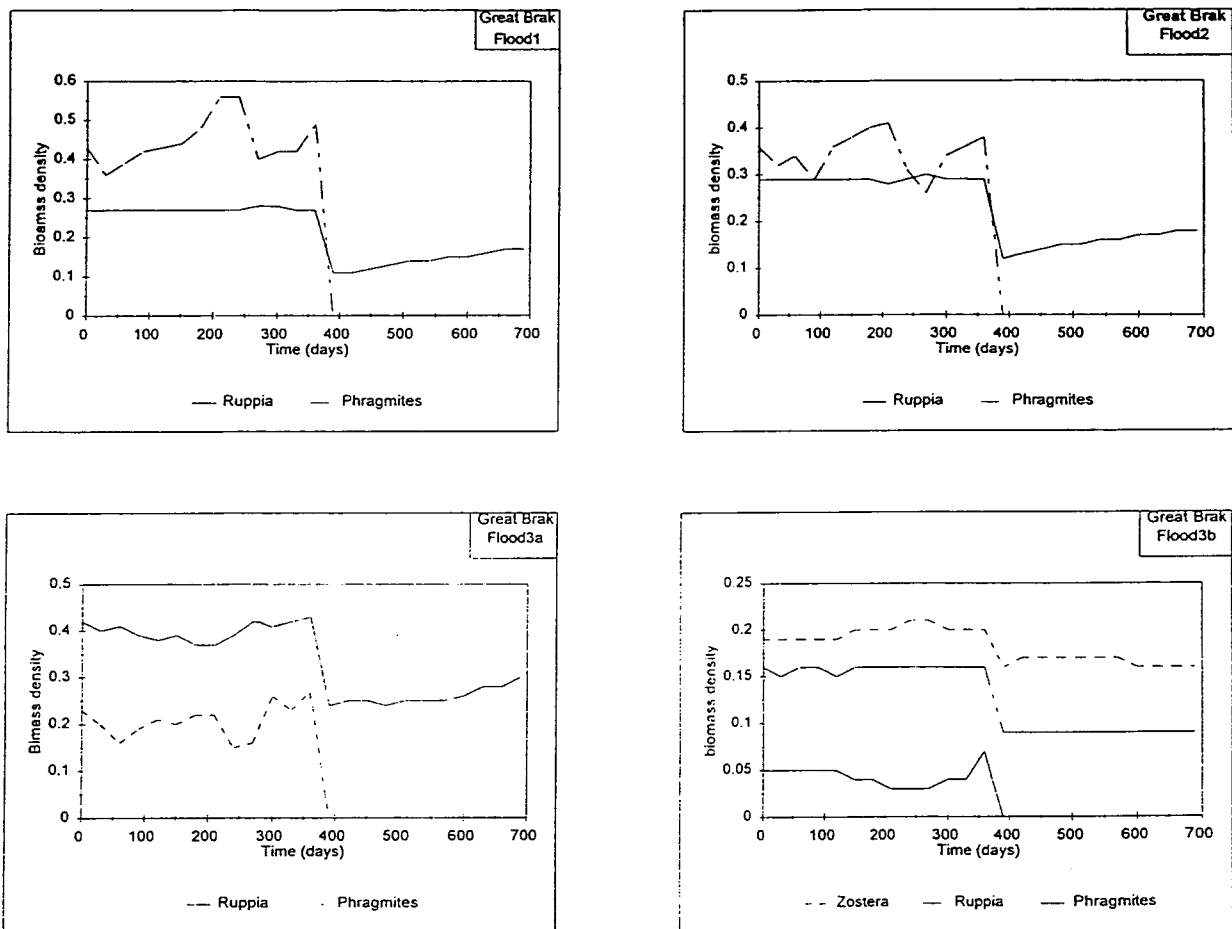

Figure 5.14 The effects of flood disturbances on scenario 1 (top left), 2 (top right), 3a (bottom left) and 3b (bottom right). The sharp decrease in biomass at the beginning of the second year is caused by the onset of the flood

Model Limitations and Ranges of Applicability

Simulation models for the growth of estuarine macrophytes are relatively complex, owing to the interplay of mechanisms that determine whether a macrophyte will grow on a certain site, and how well it will perform. The aim of the dynamic vegetation model was to predict the response of estuarine macrophytes in relation to reductions in freshwater inflow and associated changes in the physical environment of the plant. For this reason, the determinants of macrophyte growth were salinity, water levels and current velocity. Other factors such as turbidity, soil nutrients and temperature were taken to be constant at values optimal for macrophyte growth.

The vegetation model predicts the response of the plants to salinity, water level and current velocity, which are directly affected by freshwater input. Dynamic factors such as expansion of marine species into the upper reaches is predicted. Trends such as an increase in *Zostera* areal cover over 20 years can be predicted. Competition between species can also be predicted, e.g. when water levels drop, *Ruppia* dies back and is replaced by *Phragmites*.

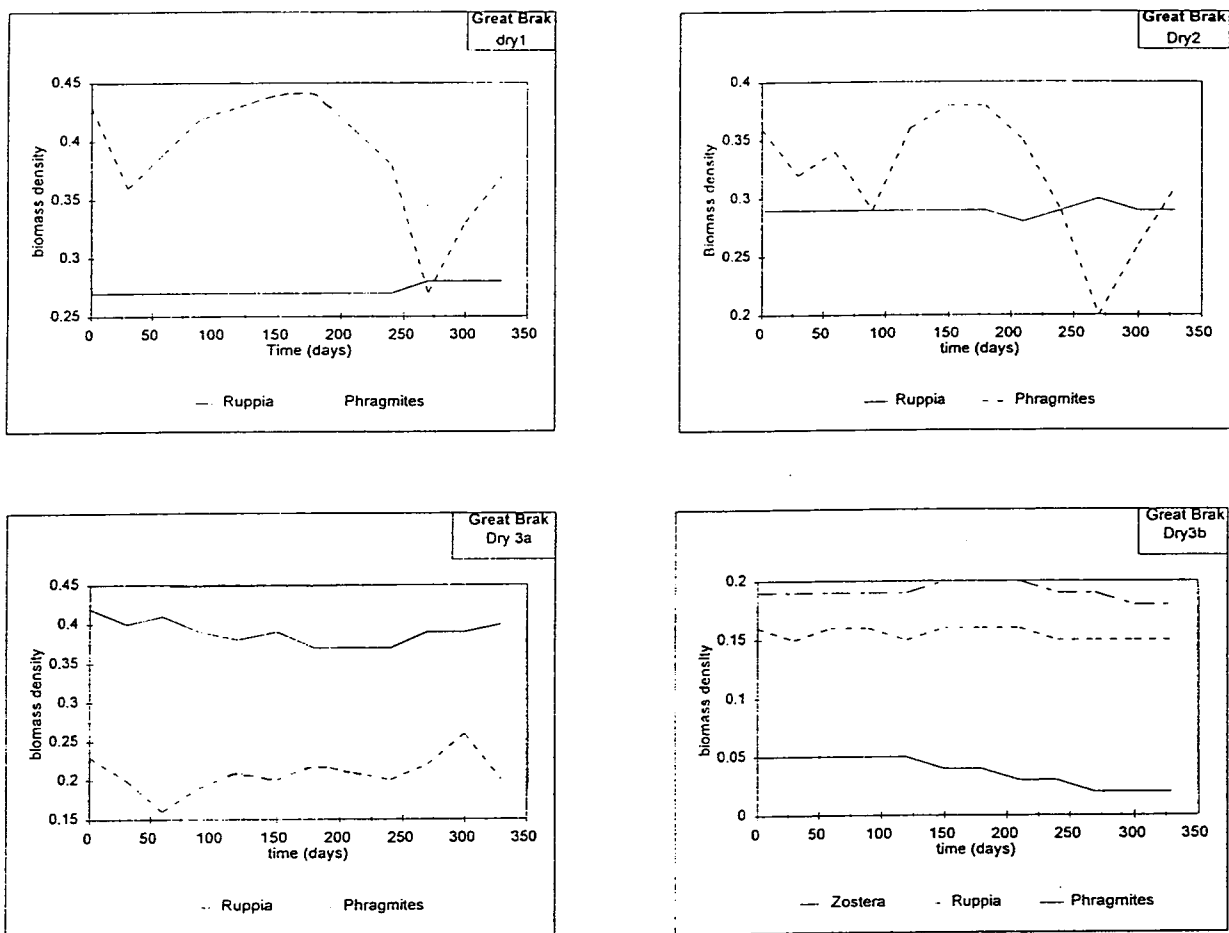

Figure 5.15 The effects of the dry disturbance on scenarios 1 (top left), 2 (top right), 3a (bottom left) and 3b (bottom right)

5.3.6 The Estuarine Ecosystem Evaluation Model

The fish recruitment predictions are depicted graphically in Figure 5.16, while the responses of *Upogebia africana* to the different run-off scenarios are depicted in Figure 5.17.

1. *Natural run-off scenario*

Under the natural run-off scenario the mouth closes for approximately two weeks in June due to low inflow, thereby limiting the recruitment of juvenile fish. During the remainder of the simulation, the mouth is open and the axial salinity difference is significantly higher than 20 ppt, and as a consequence fish recruitment occurs at the potential maximum resulting in a mean annual score of 96. Furthermore, the mouth closure occurs at a time when only three of the possible 14 species are recruiting.

This simulation also corresponds to the highest production level for *Upogebia africana*, reaching approximately 130 000 g.m⁻², under conditions of dynamic equilibrium. Size class frequency histograms show that all size classes are represented throughout the period of simulation, with the prawns reaching a maximum carapace length of 25 mm.

2. *Pre-dam run-off scenario*

A reduction in inflow due to attenuation by minor impoundments as well as abstraction results in a more frequent mouth closure with the mouth closing in late December as well as in June. However, as freshwater flow is sufficient to maintain the axial salinity gradients, recruitment occurs at maximum potential, except for periods of mouth closure. Although the mouth closure occurs at the peak of the recruitment period, the duration of mouth closure constitutes only 12% of the peak recruiting period, and thus the mean annual score remains high at 89.

Production of *Upogebia africana* is reduced relative to the natural run-off scenario, with biomass stabilising at approximately 110 000 g.m⁻². Gaps in the size class frequency histograms (e.g. day 2000) represent periods when no recruitment was possible due to mouth closure.

3a. *Post-dam scenario (with high base flow)*

Under this scenario the mouth is closed for much of the time, with reductions in the axial salinity gradient occurring in response to reduced inflow. Nevertheless the mouth is open for sufficient periods of time to permit recruitment for all 14 species to occur. The mean annual score is reduced to 43.

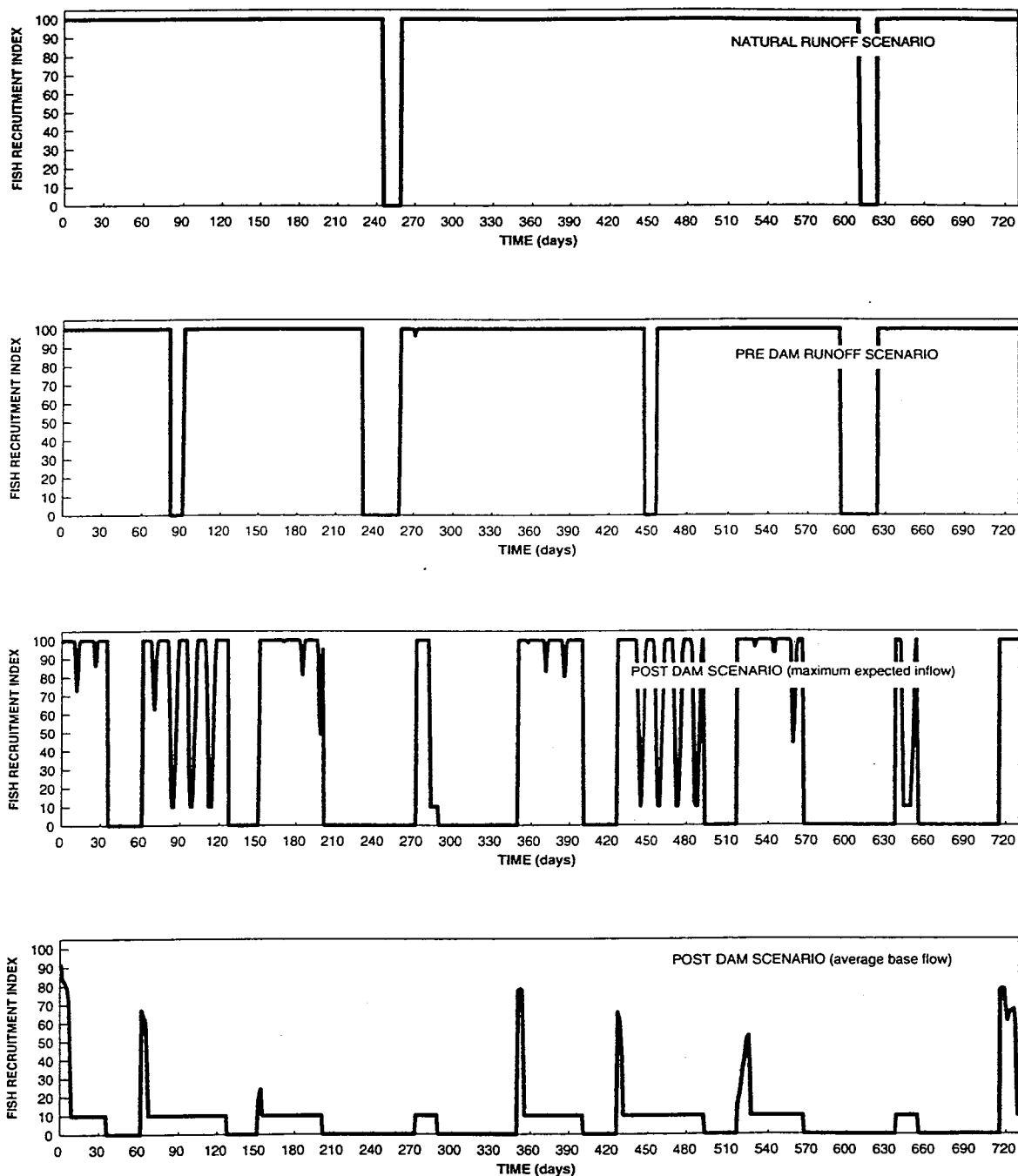
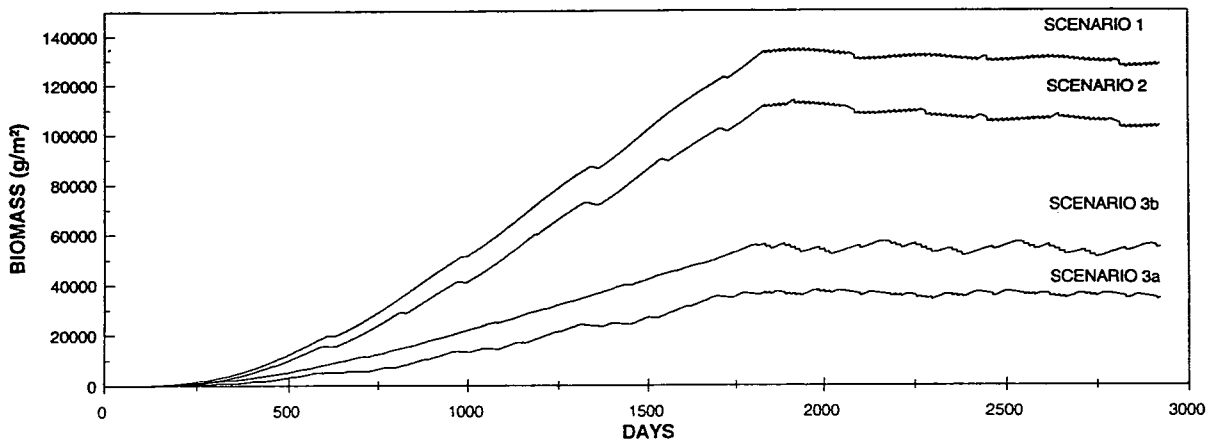

Figure 5.16 The effects of the different freshwater run-off scenarios on the fish recruitment to the Great Brak Estuary

Figure 5.17 The biomass production and size class histograms of *Upogebia africana* under (overleaf) the different run-off scenarios to the Great Brak Estuary

BIOMASS PRODUCTION
Upogebia africana



SCENARIO 1 : DAY 500

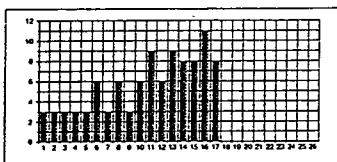

SCENARIO 2 : DAY 500

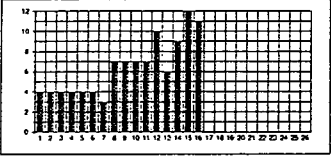

SCENARIO 3a : DAY 500

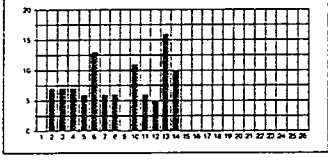

SCENARIO 3b : DAY 500

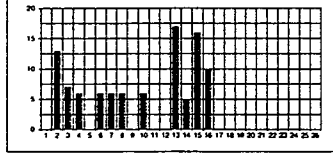

SCENARIO 1 : DAY 1000

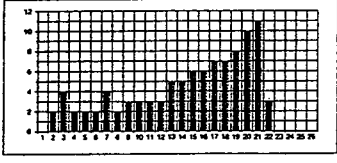

SCENARIO 2 : DAY 1000

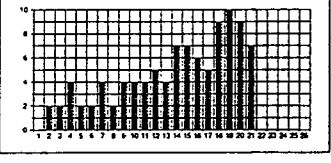

SCENARIO 3a : DAY 1000

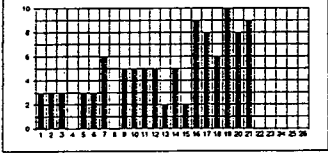

SCENARIO 3b : DAY 1000

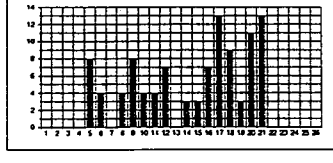

SCENARIO 1 : DAY 1500

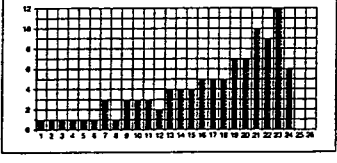

SCENARIO 2 : DAY 1500

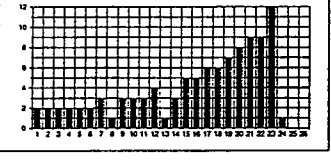

SCENARIO 3a : DAY 1500

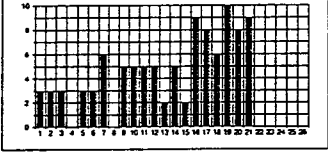

SCENARIO 3b : DAY 1500

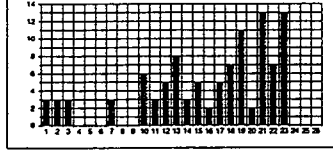

SCENARIO 1 : DAY 2000

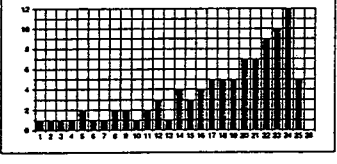

SCENARIO 2 : DAY 2000

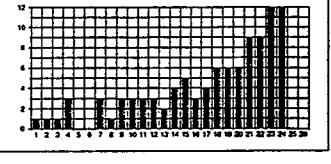

SCENARIO 3a : DAY 2000

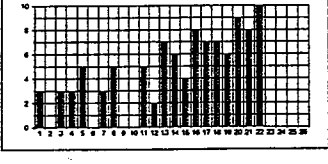

SCENARIO 3b : DAY 2000

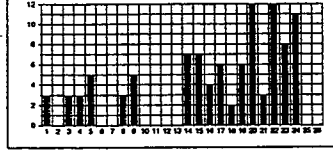

SCENARIO 1 : DAY 2500

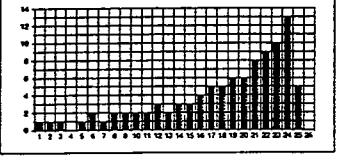

SCENARIO 2 : DAY 2500

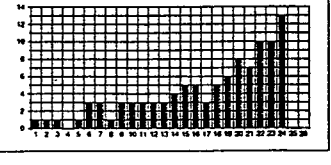

SCENARIO 3a : DAY 2500

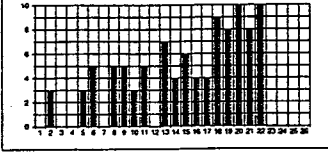

SCENARIO 3b : DAY 2500

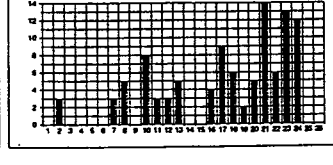

SCENARIO 1 : DAY 2900

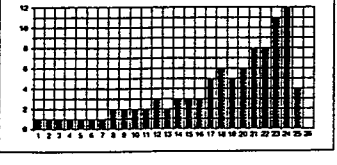

SCENARIO 2 : DAY 2900

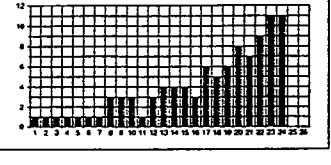

SCENARIO 3a : DAY 2900

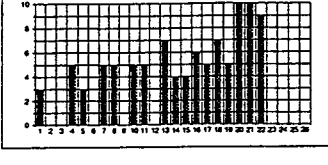

SCENARIO 3b : DAY 2900

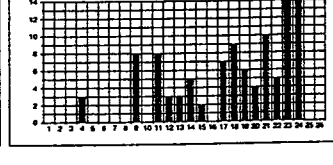

Production of *Upogebia africana* was the lowest of all the scenarios in this simulation. The reason for this was that although mouth conditions were the same for this simulation and the following simulation, physico-chemical conditions in the estuary under this scenario were less suitable for *Upogebia africana*. As a consequence growth was slower, as indicated by the fact that the maximum size class represented at the end of the simulation is only 22 mm. Biomass stabilizes at approximately 40 000 g.m⁻².

3b. *Post-dam scenario (low base flow)*

Flow is sufficient to maintain an open mouth for a similar period of time, although axial salinity differences are severely reduced due to limited inflow. As a consequence recruitment never reaches its potential maximum and a very low annual score of 8 results.

Although conditions are not ideal for the recruitment of juvenile fish, conditions are better for *Upogebia africana*, relative to the high base flow situation. The maximum size of powans is comparable to the first two simulations, although there are larger gaps in the size class frequency distributions due to less frequent opportunities for recruitment.

5.3.7 Summary

The Mike 11 hydrodynamic and transport-dispersion modules were successfully applied to the simulation of water levels, salinities, flows and velocities in the Great Brak Estuary under open mouth conditions for the natural, pre-dam and post-dam run-off scenarios. Additionally, the intrusion of salinities into the estuary after a flood had flushed all salt from the system, was modelled for each run-off scenario. The Estuarine Systems Model, on the other hand, was able to simulate the closure and subsequent breaching of the estuary mouth yielding predictions of the abiotic environment over a full two year period for each of the run-off scenarios. The effects of flood and dry disturbances to the steady dynamic states of the abiotic environment were also simulated. It is noteworthy that in the case of the temporarily closed Great Brak Estuary, the Mike 11 and ESM models complement one another very well in that:

- Mike 11 supplies accurate longitudinal salinity predictions, and
- the ESM simulates the closure and opening of the estuary mouth (and the associated physical responses).

PEDSSys and the DVM utilized the simulations from both the Mike 11 and ESM models to predict the response of the estuarine macrophytes both qualitatively and quantitatively. Under

the natural and pre-dam situations an axial gradient in salinities is maintained and macrophyte diversity is high. Under the post-dam run-off scenarios, higher salinities and reduced head to mouth differences lead to reduced vigour of the brackish species such as *Sporobolus* and *Phragmites* and the encroachment of the salt-loving *Zostera* up the estuary. Closed mouth conditions are more detrimental to the plants than open mouth conditions owing to high water levels. According to PEDSSys the worst case scenario for the plants was an open mouth with 50% less base flow. Water levels were then less than under the corresponding steady dynamic state, causing submerged plants to suffer exposure and emergent plants to suffer drying of the sediment. The DVM predicted that *Phragmites* would die-off following flooding at the onset of the second year of the simulation period. This is considered too severe an effect and refinement of this feature of the model is required so that more realistic predictions can be made. However, the DVM concurred with PEDSSys in predicting the spread of *Zostera* into the upper reaches with reductions in freshwater flow and is also able to predict the expansion of *Phragmites* into areas previously dominated by *Ruppia*, which occurs when water levels decrease.

The EEEM used the simulation data from the ESM to predict the effects of the different run-off scenarios on fish recruitment and the population levels and structure of the mud prawn, *Upogebia africana*. Fish recruitment decreased with decreasing freshwater flow and increased mouth closure, although the differences are not significant between the natural and the pre-dam situations. The total biomass and the population structure of *Upogebia africana* was affected substantially by the increased mouth closure and the abiotic environment of the estuary following construction of the impoundment.

6 DISCUSSION AND CONCLUSIONS

6.1 The Linked Modelling System: Summary of Results

In the first year of the Predictive Capability sub-project of the Co-ordinated Research Programme on Decision Support for the Conservation and Management of Estuaries, model applications were undertaken on the small, intermittently closed Great Brak Estuary. Initially attention focused on implementing five existing models in a linked fashion on the case study. This was undertaken successfully within the first year, partially meeting the aims of the sub-project. However, the implementation of the existing models did not imply that all issues relating to meaningful prediction had been tackled. For instance, the simulation of the effects of the closure of the estuary mouth on the physical dynamics of the estuary could not be simulated in the first year of the project, nor could any quantitative predictions be made of the spatial dynamics of the estuarine macrophytes. The case study application, therefore, demonstrated that a linked modelling approach could work, but highlighted shortcomings in the models themselves and in the means of application of the linkages e.g. inefficient or inappropriate transfer of data.

In the second year of the Predictive Capability sub-project, attention was focused on the implementation of the linked modelling approach on the Kromme Estuary. The decision to focus the research work in this way arose primarily because of the success of the Great Brak Case Study in the previous year and because of the identified need to establish whether the models were applicable to a larger, permanently open system. It was also considered that by focusing on a real application, theoretically appealing, but unnecessary, developments to the models would be avoided.

A variety of inflow scenarios to the Kromme Estuary were formulated. These ranged from the natural run-off situation, through intermediate run-off situations in which annual allocations of freshwater equivalent to 40%, 20% and 10% of the natural mean annual run-off were deemed to enter the estuary, to situations of no freshwater flow for up to three years. Model simulations were conducted for each of these scenarios by the Mike 11 hydrodynamic and transport-dispersion modules and the Estuarine Systems Model and daily averaged results were supplied to the other models or predictive tools comprising the linked modelling system. In terms of the short term predictive capability, the Plant Estuarine Decision Support System was then implemented using data generated by Mike 11 and yielding qualitative predictions of the

response of the estuarine macrophytes to all of the different inflow scenarios. Comments on the response of the phytoplankton were made with the aid of the results from the Estuarine Systems Model. The Mike 11 water quality module was also implemented with estimated parameter values, but the results are unrealistic owing to a lack of calibration data. Finally, qualitative short term faunal prediction was undertaken for five of the eight scenarios by a group of faunal experts. While these predictions are uncalibrated, data are available on the state of the ecosystem of the Kromme Estuary prior and post upstream impoundment and could prove useful as a means of calibration. The potential to further formalise this method of prediction is illustrated through the formulation of a fish recruitment index and its inclusion in the Estuarine Ecosystem Evaluation Model.

The linked long term predictive capability was implemented on the Kromme Estuary through the transfer of model data from the Estuarine Systems Model to the Dynamic Vegetation Model and the Estuarine Evaluation Model. The Dynamic Vegetation Model was implemented comprehensively on five of the run-off scenarios and yielded quantitative results which accorded with the qualitative predictions from PEDSSys. Dynamic prediction of the response of the estuarine flora to different run-off scenarios was enhanced by considering the spatial response of two species, namely *Phragmites* and *Zostera*, because *Phragmites* favours brackish conditions whereas *Zostera* favours saline conditions. The invertebrate production index of the Estuarine Ecosystem Evaluation Model proved a disappointing indicator of ecosystem functioning for the permanently open Kromme Estuary. However, results from the application of the fish recruitment index indicated that recruitment was severely affected by strong reductions in freshwater flow with only those scenarios receiving freshwater flows equivalent to 10% of the natural MAR and greater experiencing significant recruitment. Thus, the long term predictive capability proved applicable to the relatively long, permanently open system of the Kromme Estuary.

In the final year of the predictive capability sub-project, the Great Brak Case Study was revisited and improved predictions were made using the linked modelling approach. Four run-off scenarios were generated, encompassing the natural and pre-dam situations as well as a high base flow and a low base flow post-dam situation. Model simulations of the abiotic environment were conducted for open mouth and post flood situations over a 28 day period using Mike 11, while the Estuarine Systems Model generated predictions of the closure and opening of the mouth and the associated physico-chemical response of the water body over a two year period for each of the run-off scenarios. Flood and dry disturbance simulations were also conducted. The Mike 11 water quality module was applied to the estuary, but predictions are uncalibrated owing to a

lack of appropriate data. However, the along-estuary response of the estuarine plants to mouth closure was predicted by PEDSSys using Mike 11 data and the response of the estuarine plants to mouth closure was predicted using the ESM data. The quantitative response of *Zostera*, *Ruppia* and *Phragmites* to the different run-off scenarios was simulated by the DVM using data from both the physical dynamics models. The predictions of both vegetation models correspond well for *Zostera* and *Ruppia*, indicating that under the natural situation *Zostera* would thrive only in the lower reaches, but that *Ruppia* would occur throughout the estuary. *Phragmites* would occur in the lower reaches under this scenario. Under the pre-dam situation, *Zostera* occurs throughout the estuary as does *Ruppia*. Under the post-dam scenario, the high salinities and low axial salinity gradients cause a further reduction in the along estuary macrophyte diversity, while the mouth closure events mean that the plants are inundated more frequently and for longer periods, reducing their biomass. The effect of mouth closure is evident in the response of the *Upogebia africana* as simulated by the EEEM, which exhibits lower population biomass and discrete size class histograms under the post-dam run-off scenarios compared with the pre-dam and natural run-off scenarios. The fish recruitment index decreases with a reduction in freshwater flow owing to reduced axial salinity gradients and increased mouth closure. Thus the linked modelling system proved applicable to a temporarily closed estuary, although the component models were used in a complementary fashion rather than purely as short term and long term predictive capabilities. This is demonstrated most effectively in the use by both PEDSSys and the DVM of the Mike 11 data for spatially-differentiated prediction and the ESM data for prediction of the effects of mouth closure and opening.

Thus at the end of the first three years of the predictive capability sub-project, an effective system of linked models has been developed and applied to both a permanently open and a temporarily closed estuary. Apart from Mike 11, the models comprising the linked system have undergone considerable development since the start of the project and increased confidence can now be placed in their predictions. Furthermore, the scenario-based simulation approach has proved effective as a means of predicting the effects of reduced freshwater flows to estuaries. It remains to indicate how the developments which have occurred in the predictive capabilities of estuarine scientists may be used in supporting decision making regarding the management of South African estuaries.

6.2 Use of the Predictive Capability for Estuaries

At the inception of the Co-ordinated Research Programme on Decision Support for the Conservation and Management of Estuaries, it was decided that the approach of the research programme would be to support and develop existing decision support procedures as far as possible, while implementing alternative procedures if those already in place were deemed inappropriate. Accordingly, a decision to support the Integrated Environmental Management procedure (DEA 1992) which forms the basis of the decision making regarding the Instream Flow Requirements of rivers as undertaken by the Department of Water Affairs and Forestry and is advocated by the Department of Environmental Affairs and Tourism, and its application to estuaries was taken. In this regard, it is essential that the application of the Integrated Environmental Procedure to estuaries and the place of the predictive capability for estuaries in this approach to decision-making is understood by resource managers and scientists alike. The relationship between the use of the linked modelling approach and the IEM procedure is detailed in Table 33.

A popular misconception is that the IEM procedure is used only in the context of an environmental impact assessment. In truth, this procedure is applicable in any management decision making related to the environment. This is particularly so in the case of decisions regarding the freshwater supply to estuaries as the IEM procedure facilitates iterative consideration of the consequences of different proposed scenarios i.e. decision making where uncertainty is present as to the future state or response of a system.

A further advantage is that the predictive capability can be applied at different levels of complexity and detail (Table 33) from the stage of applying an individual model, to just convening a meeting of all modellers / estuarine scientists and drawing upon their predictive expertise, to a full application of the linked modelling system. The data requirements for the different levels of application are understood for the different models, enabling the design of site specific monitoring strategies, if required. In the worst case of a data- and time-poor situation in which a predictive approach is required, the approach adopted would include a initial assessment of available data and scoping of the problem using existing expertise, next the initiation of a directed and cost-effective monitoring programme to collect absolutely essential data, some specialist research if required, then a scenario-based approach and prediction, followed by refinement of the initial assessment, subsequent monitoring and final re-assessment.

Table 33 The relationship between the IEM procedure and prediction in estuaries

IEM ACTIVITY		Predictive Activities	Accuracy
Level 1	Scoping	Use specialist expertise and available data together with rule-based predictive models to provide qualitative prediction, identify key issues and recommend further studies	Low
Level 2	Initial Specialist Studies	Preliminary modelling studies on key issues can be undertaken for various management scenarios with fairly rough data and predictions on the ranges of impact to an estuary or impacts on certain categories of estuaries can be made. Requirements for the refinement of predictions can be indicated, NO GO points identified and the significance of the initial results can be assessed.	Moderate
Level 3	Detailed Studies	Detailed study of a particular system would be undertaken at this level. Field data would be collected for model application e.g. information on water level variations, salinities, temperatures, water quality parameters such as dissolved oxygen concentrations and bacterial counts, macro-invertebrate populations and vegetation. Models would be used to refine the predictions of a level 2 investigation and to further investigate critical issues. Calibrated and validated predictions for a particular estuary would be produced. Predictions would provide the basis for the development of a management plan for the estuary. Goal directed research and management would be undertaken on the system	High
Level 4	Research	Ongoing monitoring and background studies would occur. Model predictions would be used to evaluate and enhance the application of the management plan developed in level 3. Testing and refinement of the models would occur and necessary model developments and improvements would be undertaken	Very high

There are multiple entry points into the predictive capability and its application. These arise from the shared understanding, developed amongst CERM members and modellers over the duration of the project, of the required linkages in terms of data and the appropriate complexity of model applications for effective implementation. This understanding incorporates the knowledge that the models and data generally cannot be handed over to managers or other estuarine scientists to run for themselves. One needs expertise to run a model and critically assess model output and so models and modellers are not separate from one another. Limitations of the predictive capability include:

- the actual state of the ecosystem at a particular time cannot be predicted, but the likely state of an ecosystem or the possible range of states it will occupy can be indicated. The full ecosystem response also cannot be predicted, only the responses of indicator species, key communities or indices of biotic functioning / processes for which models exist can be simulated. In particular, considerable gaps exist in the predictive capability with regard to faunal response prediction and water quality prediction.
- water quality prediction is in its infancy in South Africa, but is currently an active area of research owing to recommendations arising from this sub-project.

The predictive capability cannot be operated in isolation of water managers and other estuarine environmental managers. Closer collaboration is required to ensure the full applicability of the predictive capability decision support system.

Finally, informed decision making relies heavily on the availability of reliable information. Similarly, the estuarine models require certain basic data before their implementation can even be considered. It is advisable that recommendations for the routine acquisition of fundamental data on key estuaries be made to the state departments concerned with such matters e.g. requirements for water level recordings and mouth monitoring to the Departments of Water Affairs and Forestry and Environmental Affairs and Tourism. This will ensure that these aspects are taken into consideration in the review of the water law and the necessary monitoring activities are undertaken on estuaries both at present and in future.

REFERENCES

- ADAMS J B & BATE G C (1994a). The ecological implications of tolerance to salinity by *Ruppia cirrhosa* (Petagna) Grande and *Zostera capensis* Setchell. *Botanica Marina* 37: 449-456.
- ADAMS J B & BATE G C (1994b). The tolerance to desiccation of the submerged macrophytes *Ruppia cirrhosa* Petagna (Grande) and *Zostera capensis* Setchell. *Journal of Experimental Marine Biology and Ecology* 183: 53-62.
- ADAMS J B & BATE G C (1994c). The freshwater requirements of estuarine plants incorporating the development of an estuarine decision support system. Water Research Commission Report No. 292/2/94. 147 pp.
- ADAMS J B & TALBOT M M B (1992). The influence of river impoundment on the estuarine seagrass *Zostera capensis* Setchell. *Botanica Marina* 35: 69-75.
- BAIRD D & HEYMANS S (1994). A comparative study of energy flow in the Kromme Estuary during periods of freshwater inflow (pre 1984) and drought (1988-1992) respectively: a network analysis approach. Proc. Aquatic Ecosystems - Ecology, Conservation & Management Conference, 13-16 July 1994, Port Elizabeth.
- BREEN C M, EVERSON E C and ROGERS K (1977). Ecological studies on *Sporobolus virginicus* (L.) Kunth with particular reference to salinity and inundation. *Hydrobiologia* 54: 135-140.
- BICKERTON I B & PIERCE S M (1988). Estuaries of the Cape: Part II: Synopses of available information on individual systems. Report 33. Krom (CMS 45), Seekoei (CMS 46) and Kabeljous (CMS 47). Heydorn A E F & Morant P D (eds.). CSIR Research Report 432, Stellenbosch. 109pp.
- BUSSE J, HEARNE J W & ADAMS J B (1994). Mathematical modelling of estuarine macrophytes. Proc. Aquatic Ecosystems - Ecology, Conservation & Management Conference, 13-16 July 1994, Port Elizabeth.
- CSIR (1990). Great Brak River Estuary environmental study with reference to a management plan for the Wolwedans Dam and the Great Brak river mouth. CSIR Report EMA-C9036.

CSIR (1991). Sedimentation in the Kromme Estuary: Data Report. CSIR Report EMA-D9108, Stellenbosch.

CSIR (1992). Great Brak Estuary Management Programme. Report on the monitoring results for the period April 1990 to March 1992. CSIR Report EMAS-C92083.

CSIR (1994). Modelling salinity distributions in the Kromme Estuary under different freshwater inflow scenarios. CSIR Report EMAS-C-94051, Stellenbosch. 17pp.

DHI (1992). Mike 11. A microcomputer based modelling system for rivers and channels. Reference Manual. Danish Hydraulics Institute, Holstrom, Denmark.

HANEKOM N (1982). An ecological study in the *Zostera* beds in the Kromme estuary. SANCOR Report. Zoology Department, University of Port Elizabeth, Port Elizabeth. 163pp.

HEARNE J W & QUINN N (1994). Determining freshwater requirements for ecosystems in Southern African estuaries. Thirteenth Pacific Coast Resource Modeling Conference, July 1994, San Diego, California.

HUIZINGA P (1985). A dynamic one-dimensional water quality model. CSIR Research Report 562, Stellenbosch. 23pp.

JEZEWSKI W A & ROBERTS C P R (1986). Estuarine and lake freshwater requirements. Department of Water Affairs Technical Report TR129, Pretoria. 22pp.

NINHAM SHAND INC. (1993). Algoa Water Resources Systems Analysis. Instream flow requirements for the Algoa Region.

SLINGER J H (1989). An estuarine circulation study. Proc. Fourth South African National Hydrological Symposium, 20-22 November 1989, Pretoria.

SLINGER J H (1991). Estuarine systems management - A modelling approach. Proc. Marine, Estuarine and Freshwater Ecosystems Conference, 9-11 July 1991, Grahamstown.

SLINGER J H (1992). Using an estuarine systems model to evaluate management policy. Proc. Aquatic Ecosystems Conference, 7-10 July 1992, Cape Town.

SLINGER J H (1994). Progress report of the predictive capability sub-project (April 1993 to March 1994). A co-ordinated research programme on decision support for the conservation and

management of estuaries. Water Research Commission Report on Project No. K5/577/0/1 undertaken by the Consortium for Estuarine Research and Management. 64pp.

SLINGER J H, TALJAARD S & LARGIER J L (1994). Changes in estuarine water quality in response to a freshwater flow event. In: *Changes in Fluxes in Estuaries*, (ed. K R Dyer & R J Orth). ECSA22/ERF Symposium. Olsen & Olsen, Fredensborg, Denmark. 51-56.

STEWART T J, SCOTT L & ILONIK (1993). Scenario based multicriteria policy planning for water management in South Africa. Final Report to the Water Research Commission on the Project "Quantitative structuring of national water planning objectives for use in decision support systems in South Africa". 59pp.

LIST OF FIGURES

- Figure 3.1 Linkages between existing estuarine models.
- Figure 4.1 Map of the Kromme Estuary, the case study site. Note the positions of the ringed cross-sections for which water level, salinity and flow data are provided by the Mike 11 model. The upper reaches of the estuary are considered to extend from the head of tidal influence (14 km upstream of the mouth) to the confluence with the Geelhoutboom River, the middle reaches to cross-section 4, while the shallow, lower reaches lie downstream of this point.
- Figure 4.2 Mike 11 predictions under the natural run-off scenario at the mouth (a), in the middle reaches (b & c) and in the upper reaches (d).
- Figure 4.3 Mike 11 predictions under the intermediate run-off scenario 2 at the mouth (a), in the middle reaches (b & c) and in the upper reaches (d).
- Figure 4.4 Mike 11 predictions under the present run-off scenario at the mouth (a), in the middle reaches (b & c) and in the upper reaches (d).
- Figure 4.5 Mike 11 predictions under run-off scenario 4a at the mouth (a), in the middle reaches (b & c) and in the upper reaches (d).
- Figure 4.6 Mike 11 predictions under run-off scenario 4b at the mouth (a), in the middle reaches (b & c) and in the upper reaches (d).
- Figure 4.7 Mike 11 predictions under run-off scenario 4c at the mouth (a), in the middle reaches (b & c) and in the upper reaches (d).
- Figure 4.8 Mike 11 predictions under run-off scenario 4d at the mouth (a), in the middle reaches (b & c) and in the upper reaches (d).
- Figure 4.9 Mike 11 predictions under run-off scenario 5 at the mouth (a), in the middle reaches (b & c) and in the upper reaches (d).
- Figure 4.10 Mike 11 predictions under run-off scenario 6 at the mouth (a), in the middle reaches (b & c) and in the upper reaches (d).

- Figure 4.11 Mike 11 predictions under run-off scenario 7 at the mouth (a), in the middle reaches (b & c) and in the upper reaches (d).
- Figure 4.12 Mike 11 predictions under run-off scenario 8 at the mouth (a), in the middle reaches (b & c) and in the upper reaches (d).
- Figure 4.13 Average vertical dissolved oxygen concentrations simulated in the Kromme Estuary after a week of no freshwater inflow. The parameter value for BOD first order decay (k_1) is set at $k_1 = 0,2$ and the value of sediment oxygen demand (SOD) is set at $1 \text{ gO}_2\cdot\text{m}^{-2}\cdot\text{day}^{-1}$ for (a) and $0,2 \text{ gO}_2\cdot\text{m}^{-2}\cdot\text{day}^{-1}$ for (b).
- Figure 4.14 The mean salinities (a) and axial salinity differences (b) in the Kromme Estuary under the natural run-off scenario.
- Figure 4.15 The mean salinities (a) and axial salinity differences (b) in the Kromme Estuary under the intermediate run-off scenario 2.
- Figure 4.16 The mean salinities (a) and axial salinity differences (b) in the Kromme Estuary under the present run-off scenario.
- Figure 4.17 The mean salinities (a) and axial salinity differences (b) in the Kromme Estuary under run-off scenario 4a.
- Figure 4.18 The mean salinities (a) and axial salinity differences (b) in the Kromme Estuary under run-off scenario 4b.
- Figure 4.19 The mean salinities (a) and axial salinity differences (b) in the Kromme Estuary under run-off scenario 4c.
- Figure 4.20 The mean salinities (a) and axial salinity differences (b) in the Kromme Estuary under run-off scenario 4d.
- Figure 4.21 The mean salinities (a) and axial salinity differences (b) in the Kromme Estuary under run-off scenario 5.
- Figure 4.22 The mean salinities (a) and axial salinity differences (b) in the Kromme Estuary under run-off scenario 6.
- Figure 4.23 The mean salinities (a) and axial salinity differences (b) in the Kromme Estuary under run-off scenario 7.

- Figure 4.24 The lateral distribution of the equilibrium biomass of *Zostera* under the present run-off scenario (a), the natural run-off scenario (b) and scenario 4a (c).
- Figure 4.25 The fish recruitment index (a) and the invertebrate production index (b) under the natural run-off scenario.
- Figure 4.26 The fish recruitment index (a) and the invertebrate production index (b) under the intermediate run-off scenario 2.
- Figure 4.27 The fish recruitment index (a) and the invertebrate production index (b) under the present run-off scenario.
- Figure 4.28 The invertebrate production index under run-off scenario 4a.
- Figure 4.29 The invertebrate production index under run-off scenario 4b.
- Figure 4.30 The fish recruitment index (a) and the invertebrate production index (b) under run-off scenario 6.
- Figure 4.31 The fish recruitment index (a) and the invertebrate production index (b) under run-off scenario 7.
- Figure 5.1 Map of the Great Brak Estuary, the selected case study site. Note the positions R2, R4, R6, R8 (4,78 & 5,44 km) for which Mike 11 water level and salinity simulation data were provided.
- Figure 5.2 Salinities generated by Mike 11 at positions R2, R4, R6 & R8 over 28 days under the natural run-off scenario
- Figure 5.3 Salinities generated by Mike 11 at positions R2, R4, R6 & R8 over 28 days under the pre-dam run-off scenario
- Figure 5.4 Salinities generated by Mike 11 at positions R2, R4, R6 & R8 over 28 days under the post-dam run-off scenario
- Figure 5.5 The intrusion of saline water into the Great Brak Estuary over a 28 day period after a flood event under the post-dam run-off scenario
- Figure 5.6 The intrusion of saline water into the Great Brak Estuary over a 28 day period after a flood event under the natural run-off scenario

- Figure 5.7 The intrusion of saline water into the Great Brak Estuary over a 28 day period after a flood event under the pre-dam run-off scenario
- Figure 5.8 Average vertical dissolved oxygen concentrations simulated for the Great Brak Estuary under a freshwater flow of $0,76 \text{ m}^3 \cdot \text{s}^{-1}$, with parameter values of BOD decay and sediment oxygen demand set at $k_1 = 0,6$ and $\text{SOD} = 1 \text{ gO}_2 \cdot \text{m}^{-2} \cdot \text{day}^{-1}$ (a) and $k_1 = 0,2$ and $\text{SOD} = 0 \text{ gO}_2 \cdot \text{m}^{-2} \cdot \text{day}^{-1}$ (b)
- Figure 5.9 Water levels (top left), tidal flushing (top right), mean salinities (bottom left) and axial salinity differences (bottom right) simulated by the ESM over years 1 to 2 under the natural run-off scenario
- Figure 5.10 Water levels (top left), tidal flushing (top right), mean salinities (bottom left) and axial salinity differences (bottom right) simulated by the ESM over years 1 to 2 under the pre-dam run-off scenario
- Figure 5.11 Water levels (top left), tidal flushing (top right), mean salinities (bottom left) and axial salinity differences (bottom right) simulated by the ESM over years 1 to 2 under the post-dam run-off scenario with high base flow
- Figure 5.12 Water levels (top left), tidal flushing (top right), mean salinities (bottom left) and axial salinity differences (bottom right) simulated by the ESM over years 1 to 2 under the post-dam run-off scenario with low base flow
- Figure 5.13 The effect of reduced freshwater inflows on the distribution of estuarine macrophytes. Under the natural run-off scenario (left), the longitudinal salinity gradient means that the salt tolerant *Zostera* occurs at the mouth, the brackish species *Phragmites* in the upper reaches and *Ruppia* throughout. Under the post-dam scenario (right), the natural distribution of macrophytes is lost and *Zostera* has encroached upstream displacing *Phragmites* communities.
- Figure 5.14 The effects of flood disturbances on scenario 1 (top left), 2 (top right), 3a (bottom left) and 3b (bottom right). The sharp decrease in biomass at the beginning of the second year is caused by the onset of the flood
- Figure 5.15 The effects of the dry disturbance on scenarios 1 (top left), 2 (top right), 3a (bottom left) and 3b (bottom right)

Figure 5.16 The effects of the different freshwater run-off scenarios on the fish recruitment to the Great Brak Estuary

Figure 5.17 The biomass production and size class histograms of *Upogebia africana* under the different run-off scenarios to the Great Brak Estuary

LIST OF TABLES

- Table 1 The project participants and tasks involved in the development of the linked modelling system and its application to the Great Brak and Kromme Estuaries.
- Table 2 Current velocities and water levels at various sites under the natural run-off scenario. These data were obtained from Mike 11.
- Table 3 Current velocities and water levels at various sites under the no freshwater release scenario. These data were obtained from Mike 11.
- Table 4 Mean salinities under the different run-off scenarios. These data were obtained from Mike 11.
- Table 5 Growth rate adjustment scores for the submerged macrophyte *Zostera capensis* in the lower, middle and upper reaches of the estuary.
- Table 6 Growth rate adjustment scores for the emergent reed *Phragmites australis* in the lower, middle and upper reaches of the estuary.
- Table 7 Growth rate adjustment scores for the saltmarsh macrophyte *Sarcocornia perennis* in the lower, middle and upper reaches of the estuary.
- Table 8 The effects of salinity fluctuations on the estuarine plants (Intermediate scenario 10 % MAR, upper reaches)
- Table 9 The predicted impact of run-off scenarios 1 to 5 (on the left) on the fauna of the Kromme Estuary. The species group status scale ranges from 0 (maximum impact/poor status) to 10 (pristine/status good). The community status scale ranges from 0 (poor status) to 80 (pristine/status good).
- Table 10 *Zostera* productivity under the run-off scenarios 1 to 5, relative to scenario 3, for 5 positions in the Kromme Estuary.
- Table 11 The average equilibrium biomass of *Zostera* under the run-off scenarios 1 to 5, relative to scenario 3, for 5 positions in the Kromme Estuary.
- Table 12 The average equilibrium biomass of *Zostera* and *Phragmites* under the run-off

scenarios 1 to 3, for 5 positions in the Kromme Estuary.

Table 13	The settling time in years of <i>Zostera</i> under the run-off scenarios 1, 3 and 5 after a disturbance from scenario 6.
Table 14	The settling time in years of <i>Zostera</i> under the run-off scenarios 1, 3 and 5 after a disturbance from scenario 7.
Table 15	The settling time in years of <i>Zostera</i> under the run-off scenarios 1, 3 and 5 after a disturbance from scenario 8.
Table 16	Summary of results of the Estuarine Ecosystem Evaluation Model
Table 17	Average salinity values at the five sites for the different scenarios
Table 18	The growth rate adjustment scores for the submerged macrophyte, <i>Zostera capensis</i> , at different stations.
Table 19	The growth rate adjustment scores for the submerged macrophyte, <i>Ruppia cirrhosa</i> , at different stations.
Table 20	The growth rate adjustment scores for the emergent reed, <i>Phragmites australis</i> , at different stations.
Table 21	The effect of water level fluctuations on the growth rate adjustment score of <i>Phragmites australis</i> for two scenarios. (1. Pre-dam flood, Station R8, 6ppt; 2. Post-dam flood, Station R8, 26 ppt).
Table 22	The growth rate adjustment scores for the saltmarsh macrophyte, <i>Sporobolus virginicus</i> , at different stations.
Table 23	The growth rate adjustment scores for the saltmarsh macrophyte, <i>Sarcocornia perennis</i> , at different stations.
Table 24	Physical conditions and plant growth rate adjustment scores for closed and open mouth conditions under the natural run-off scenario.
Table 25	Physical conditions and plant growth rate adjustment scores for closed and open mouth conditions under the pre-dam run-off scenario.

Table 26	Physical conditions and plant growth rate adjustment scores for closed and open mouth conditions under the post-dam run-off scenario with high base flow
Table 27	Physical conditions and plant growth rate adjustment scores for closed and open mouth conditions under the post-dam run-off scenario with low base flow
Table 28	Equilibrium biomass density (g.m^{-2}) under the run-off scenarios 1,2 and 3, for 5 positions in the Great Brak Estuary (<i>Zostera Ruppia/ Phragmites</i>)
Table 29	Total average yearly productivity (g.yr^{-1}) under the run-off scenarios 1,2 and 3, for 5 positions in the Great Brak Estuary (<i>Zostera/Ruppia/Phragmites</i>)
Table 30	Equilibrium biomass density (g.m^{-2}) under the run-off scenarios 1,2 3a and 3b (<i>Zostera/ Ruppia/ Phragmites</i>)
Table 31	Total average yearly productivity (g.m^{-2}) under the run-off scenarios 1,2, 3a and 3b (<i>Zostera/Ruppia/Phragmites</i>)
Table 32	The recovery time (years) and amplitude (percentage) of disturbance of <i>Zostera</i> biomass for the ESM flood and dry disturbance scenarios. A negative amplitude means that there is a decrease in biomass after the disturbance.
Table 33	The relationship between the IEM procedure and prediction in estuaries

APPENDIX

EQUATIONS OF THE DYNAMIC VEGETATION MODEL

In this modelling exercise, systems of first order differential equations were used to determine the biomass of *Zostera*, *Ruppia* and *Phragmites* at any time and position, and their response to changes in freshwater inflow as manifested in alterations in salinities, water levels and current velocities. In the computer simulation, two dimensional space is divided into hexagonal cells. Each cell is surrounded by six equidistant cells. The cells are chosen to be small enough so that macrophytes are evenly distributed within a cell. At each site in the estuary a system of 4 by 4 cells constitutes the two dimensional space. The area of each cell is 1.36m², so that the two dimensional space covers a length along the estuary of 10.2 m and a height of 2.4m from the bottom of the estuary.

A computer program was written in Turbo Pascal to implement the model.

Model equations

Let $Z(i,j,t)$, $R(i,j,t)$ and $P(i,j,t)$ be the biomass (g) of *Zostera*, *Ruppia* and *Phragmites* at time t and in the i,j th cell. This represents the total biomass in that cell, i.e. above- and below- ground biomass. Then the growth equation for *Zostera* is given by

$$\frac{dZ}{dt} = \text{growth} + \text{expansion} \quad (1)$$

where

$$Z=Z(i,j,t);$$

growth is the increase in biomass in the i,j th cell; and

expansion is the expansion from neighbouring cells into the i,j th cell.

Growth is given by

$$\text{growth} = \text{sgr} * Z * f(\text{density}) * (1 - g(\text{density})) \quad (2)$$

where

sgr is the specific growth rate (0.005 g.g⁻¹.day⁻¹);

$f(\text{density})$ is a density multiplier that depends on the density of the i,j th cell, (figure 1a);
 and
 $g(\text{density})$ is an expansion multiplier that depends on the density of the i,j th cell, (figure 1b).

All multipliers in this paper are dimensionless and lie between 0 and 1.

The assumption on the growth of macrophytes in a cell is that growth contributes to an increase in biomass within the cell and expansion into a neighbouring cell. In equation (2) the total growth is given by $\text{sgr} \cdot Z \cdot f(\text{density})$. When the density of a cell is small, then $f(\text{density})=1$ (Figure 1a) because there is no intraspecific competition. As the density increases intraspecific competition increases and the density multiplier, and consequently the growth rate, decrease. When the cell is full the density multiplier reaches a minimum value. Expansion does not occur when the density is below a certain value, i.e. $e=0$ (Figure 1b). As the density increases there is more expansion and when the cell is full there is maximum expansion, i.e. $e=1$ (Figure 1c).

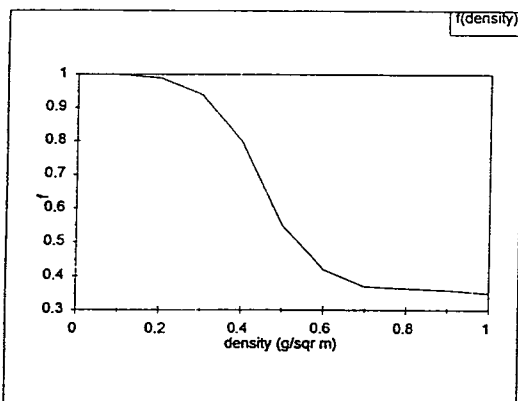

Figure 1a Graph of the density multiplier in equation (2)

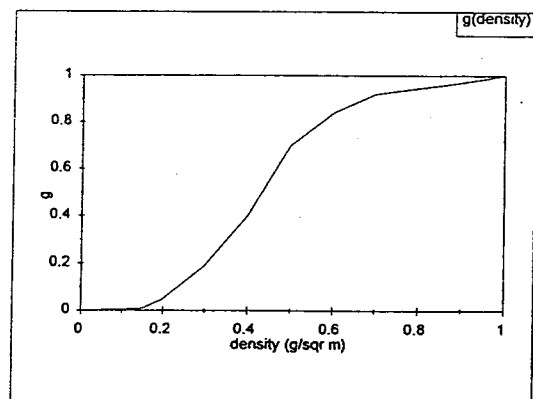

Figure 1b Graph of the expansion multiplier in equation (2)

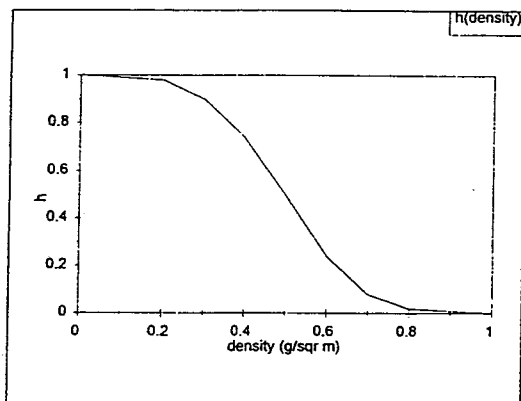

Figure 1c Graph of the expansion density multiplier in equation (3)

are determined using sine functions that follow the daily tide. The exposure multiplier is important for submerged macrophytes that do not survive above the water level. The depth multiplier is important because some macrophytes cannot survive at a certain depth below the water level due to insufficient light. The term scour is given by $\text{scour_rate} * Z * k(\text{velocity})$ where $\text{scour_rate} = 0.005 \text{ g} \cdot \text{g}^{-1} \cdot \text{day}^{-1}$ and $k(\text{velocity})$ is a function of the velocity. In floods the current velocity is high and *Zostera* is washed away.

The graphs in Figure 2 show the depth-salinity-biomass relationship for *Zostera*, *Ruppia* and *Phragmites*. The biomass values are the equilibrium values that would be achieved in the absence of other species.

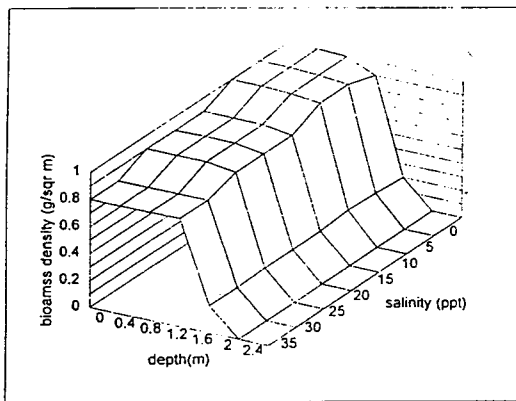

Figure 2a

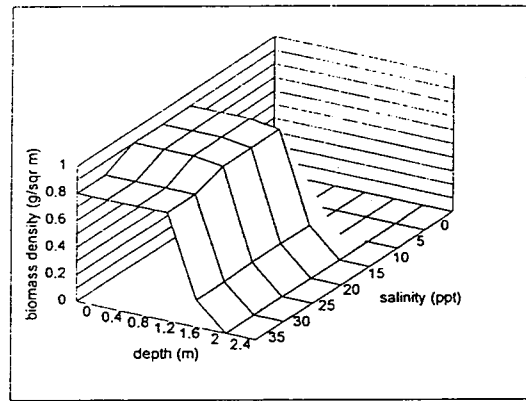

Figure 2b

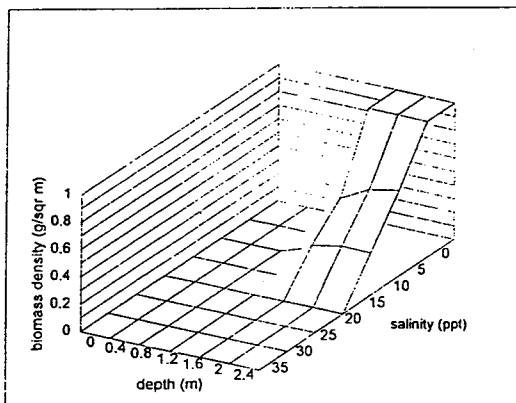

Figure 2c

Figure 2 Graphs showing the depth-biomass-salinity relationship for *Ruppia* (figure 2a), *Zostera* (figure 2b), and *Phragmites* (figure 2c). The graphs show those equilibrium biomass values that a species would attain in the absence of all other species.